

FCC Information and Copyright

This equipment has been tested and found to comply with the limits of a Class B digital device, pursuant to Part 15 of the FCC Rules. These limits are designed to provide reasonable protection against harmful interference in a residential installation. This equipment generates, uses and can radiate radio frequency energy and, if not installed and used in accordance with the instructions, may cause harmful interference to radio communications. There is no guarantee that interference will not occur in a particular installation.

The vendor makes no representations or warranties with respect to the contents here and specially disclaims any implied warranties of merchantability or fitness for any purpose. Further the vendor reserves the right to revise this publication and to make changes to the contents here without obligation to notify any party beforehand.

Duplication of this publication, in part or in whole, is not allowed without first obtaining the vendor's approval in writing.

The content of this user's manual is subject to be changed without notice and we will not be responsible for any mistakes found in this user's manual. All the brand and product names are trademarks of their respective companies.

Table of Contents

Chapter 1: Introduction	1
1.1 Before You Start	1
1.2 Package Checklist	1
1.3 Motherboard Features	2
1.4 Rear Panel Connectors (for Ver 1x & Ver 5x)	4
1.5 Rear Panel Connectors (for Ver 6x)	4
1.6 Motherboard Layout (for Ver 1x)	5
1.7 Motherboard Layout (for Ver 5x)	6
1.8 Motherboard Layout (for Ver 6x)	7
Chapter 2: Hardware Installation	8
2.1 Installing Central Processing Unit (CPU)	8
2.2 FAN Headers	10
2.3 Installing System Memory	11
2.4 Connectors and Slots	13
Chapter 3: Headers & Jumpers Setup	15
3.1 How to Setup Jumpers	15
3.2 Detail Settings	15
Chapter 4: NVIDIA RAID Functions	24
4.1 Operation System	24
4.2 Raid Arrays	24
4.3 How RAID Works	24
Chapter 5: OverClock Quick Guide	28
5.1 T-Power Introduction	28
5.2 T-Power BIOS Feature	29
5.3 T-Power Windows Feature	37
Chapter 6: Useful Help	46
6.1 Driver Installation Note	46
6.2 Award BIOS Beep Code	47
6.3 Extra Information	47
6.4 Troubleshooting	49
Appendencies: SPEC In Other Language	50
German	50
France	52
Italian	54
Spanish	56
Portuguese	58
Polish	60
RUSSIAN	62
ARABIC	64
JAPANESE	66

CHAPTER 1: INTRODUCTION

1.1 BEFORE YOU START

Thank you for choosing our product. Before you start installing the motherboard, please make sure you follow the instructions below:

- Prepare a dry and stable working environment with sufficient lighting.
- Always disconnect the computer from power outlet before operation.
- Before you take the motherboard out from anti-static bag, ground yourself properly by touching any safely grounded appliance, or use grounded wrist strap to remove the static charge.
- Avoid touching the components on motherboard or the rear side of the board unless necessary. Hold the board on the edge, do not try to bend or flex the board.
- Do not leave any unfastened small parts inside the case after installation. Loose parts will cause short circuits which may damage the equipment.
- Keep the computer from dangerous area, such as heat source, humid air and water.

1.2 PACKAGE CHECKLIST

- ✦ FDD Cable X 1
- ✦ HDD Cable X 1
- ✦ Serial ATA Cable X 1
- ✦ Serial ATA Power Cable X 1
- ✦ Rear I/O Panel for ATX Case X 1
- ✦ User's Manual X 1
- ✦ Fully Setup Driver CD X 1
- ✦ USB 2.0 Cable X1 (optional)
- ✦ S/PDIF out Cable X 1 (optional)

1.3 MOTHERBOARD FEATURES

	<i>Ver 1.x / Ver 5.x</i>	<i>Ver 6.x</i>
CPU	Socket AM2 AMDAthlon 64 / Athlon 64 FX / Athlon 64 x2 / Sempron processors AMD 64 Architecture enables 32 and 64 bit computing Supports Hyper Transport and Cool nQuiet	Socket AM2 AMDAthlon 64 / Athlon 64 FX / Athlon 64 x2 / Sempron processors AMD 64 Architecture enables 32 and 64 bit computing Supports Hyper Transport and Cool nQuiet
FSB	Support HyperTransport Supports up to 1 GHz Bandwidth	Support HyperTransport Supports up to 1 GHz Bandwidth
Chipset	nForce 570 Ultra	nForce 570 Ultra
Super I/O	ITE 8716F Provides the most commonly used legacy Super I/O functionality Low Pin Count Interface Environment Control initiatives, H/W Monitor Fan Speed Controller ITE's "Smart Guardian" function	ITE 8716F Provides the most commonly used legacy Super I/O functionality Low Pin Count Interface Environment Control initiatives, H/W Monitor Fan Speed Controller ITE's "Smart Guardian" function
Main Memory	DIMM Slots x 4 Each DIMM supports 256/512MB & 1GB DDR2 Max Memory Capacity 4GB Dual Channel Mode DDR2 memory module Supports DDR2 533 / 667 / 800 Registered DIMM and ECC DIMM is not supported	DIMM Slots x 4 Each DIMM supports 256/512MB & 1GB DDR2 Max Memory Capacity 4GB Dual Channel Mode DDR2 memory module Supports DDR2 533 / 667 / 800 Registered DIMM and ECC DIMM is not supported
IDE	Integrated IDE Controller Ultra DMA 33 / 66 / 100 / 133 Bus Master Mode supports PIO Mode 0~4,	Integrated IDE Controller Ultra DMA 33 / 66 / 100 / 133 Bus Master Mode supports PIO Mode 0~4,
SATA II	Integrated Serial ATA Controller Data transfer rates up to 3 Gb/s. SATA Version 2.0 specification compliant.	Integrated Serial ATA Controller Data transfer rates up to 3 Gb/s. SATA Version 2.0 specification compliant.
LAN	Marvell 88E1116 PHY 10 / 100 Mb/s and 1Gb/s Auto-Negotiation	Marvell 88E1116 PHY 10 / 100 Mb/s and 1Gb/s Auto-Negotiation

TForce 570 U

	Ver 1.x / Ver 5.x	Ver 6.x
Sound	Realtek ALC888 7.1 channels audio out Supports HD Audio	Realtek ALC861VD 5.1 channels audio out Supports HD Audio
Slots	PCI slot x3 PCI Express x16 slot x1 PCI Express x 1 slot x3	PCI slot x3 PCI Express x16 slot x1 PCI Express x 1 slot x3
On Board Connector	Floppy connector x1 Printer Port connector x1 IDE Connector x1 SATA Connector x6 Front Panel Connector x1 Front Audio Connector x1 CD-in Connector x1 S/PDIF out connector x1 CPU Fan header x1 System Fan header x3 Chassis open header (optional) x1 CMOS clear header x1 USB connector x2 Power Connector (24pin) x1 Power Connector (8pin) x1	Floppy connector x1 Printer Port connector x1 IDE Connector x1 SATA Connector x6 Front Panel Connector x1 Front Audio Connector x1 CD-in Connector x1 S/PDIF out connector x1 CPU Fan header x1 System Fan header x3 Chassis open header (optional) x1 CMOS clear header x1 USB connector x2 Power Connector (24pin) x1 Power Connector (8pin) x1
Back Panel I/O	PS/2 Keyboard x1 PS/2 Mouse x1 Serial Port x1 LAN port x1 USB Port x6 Audio Jack x6	PS/2 Keyboard x1 PS/2 Mouse x1 Serial Port x1 LAN port x1 USB Port x6 Audio Jack x3
Board Size	244 x 305 (mm)	244 x 305 (mm)
Special Features	NVIDIA nTune RAID 0 / 1 / 0+1 / 5 support	NVIDIA nTune RAID 0 / 1 / 0+1 / 5 support
OS Support	Windows 2000 / XP / VISTA Biostar Reserves the right to add or remove support for any OS With or without notice.	Windows 2000 / XP / VISTA Biostar Reserves the right to add or remove support for any OS With or without notice.

1.4 REAR PANEL CONNECTORS (FOR VER 1.x & VER 5.x)

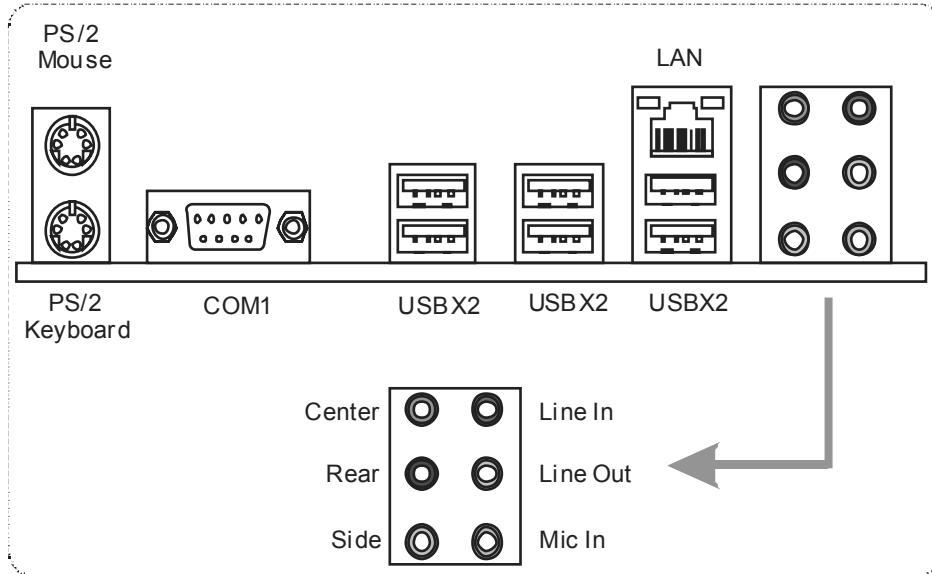

1.5 REAR PANEL CONNECTORS (FOR VER 6.x)

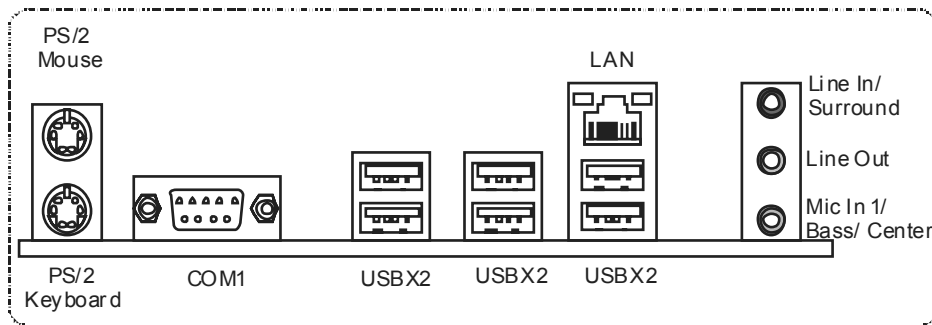

1.6 MOTHERBOARD LAYOUT (FOR VER1.X)

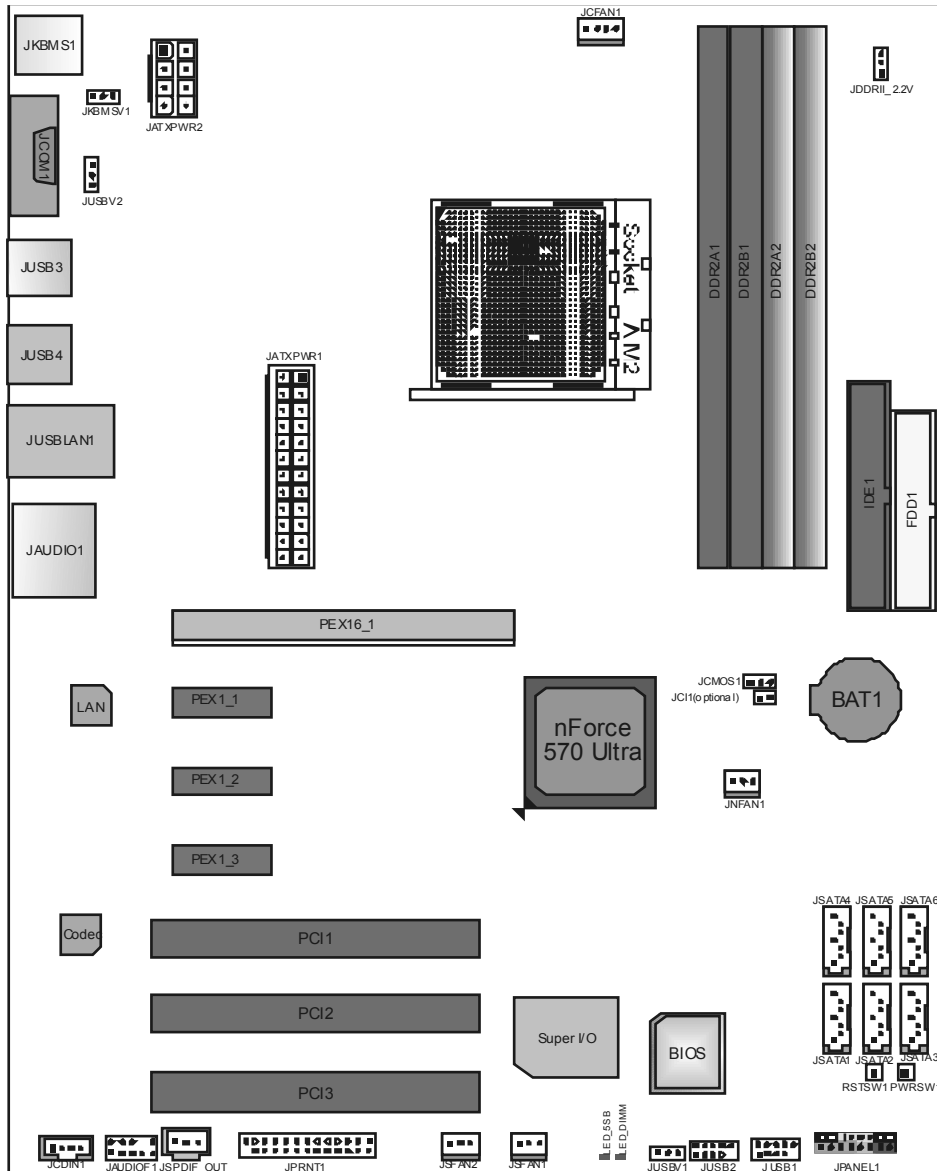

Note: ■ represents the 1st pin.

1.7 MOTHERBOARD LAYOUT (FOR VER 5.x)

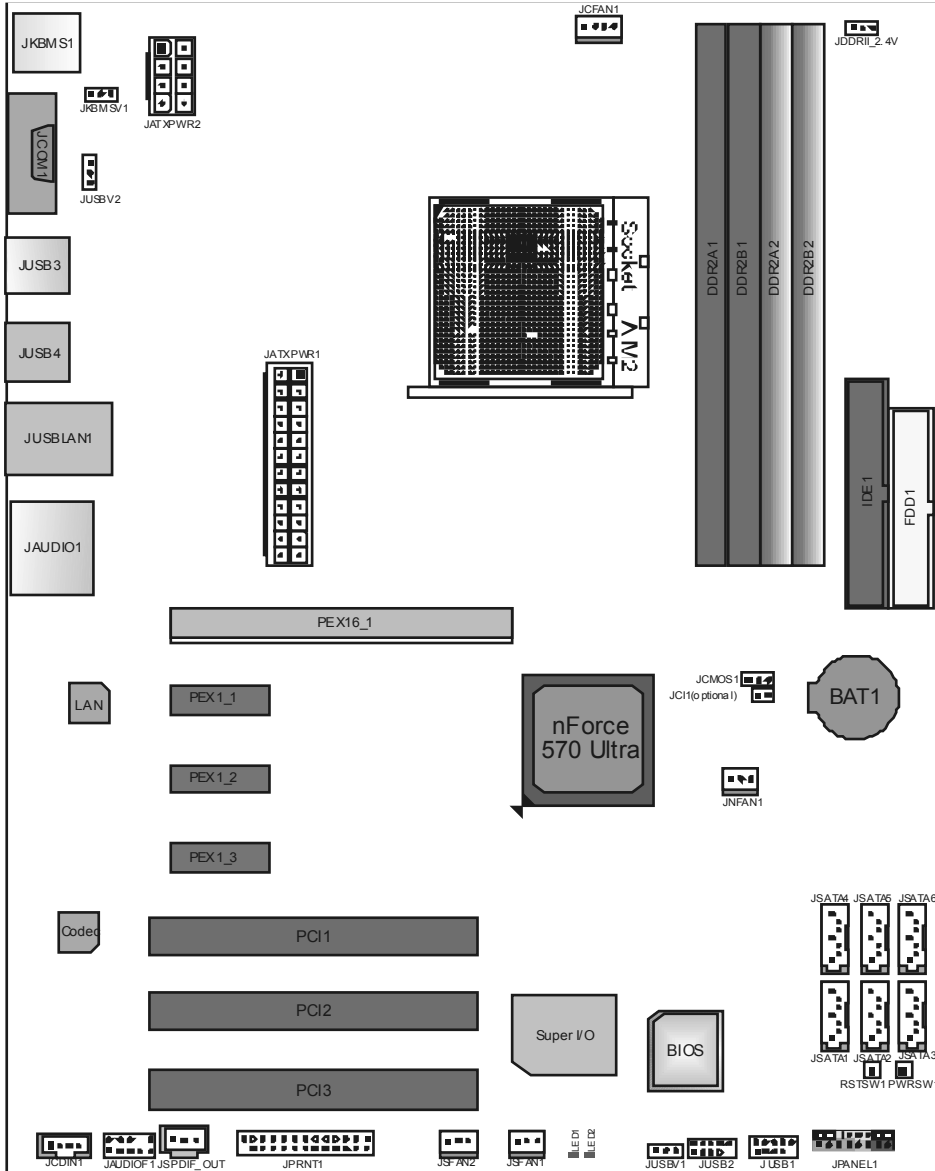

Note: ■ represents the 1st pin.

1.8 MOTHERBOARD LAYOUT (FOR VER 6.x)

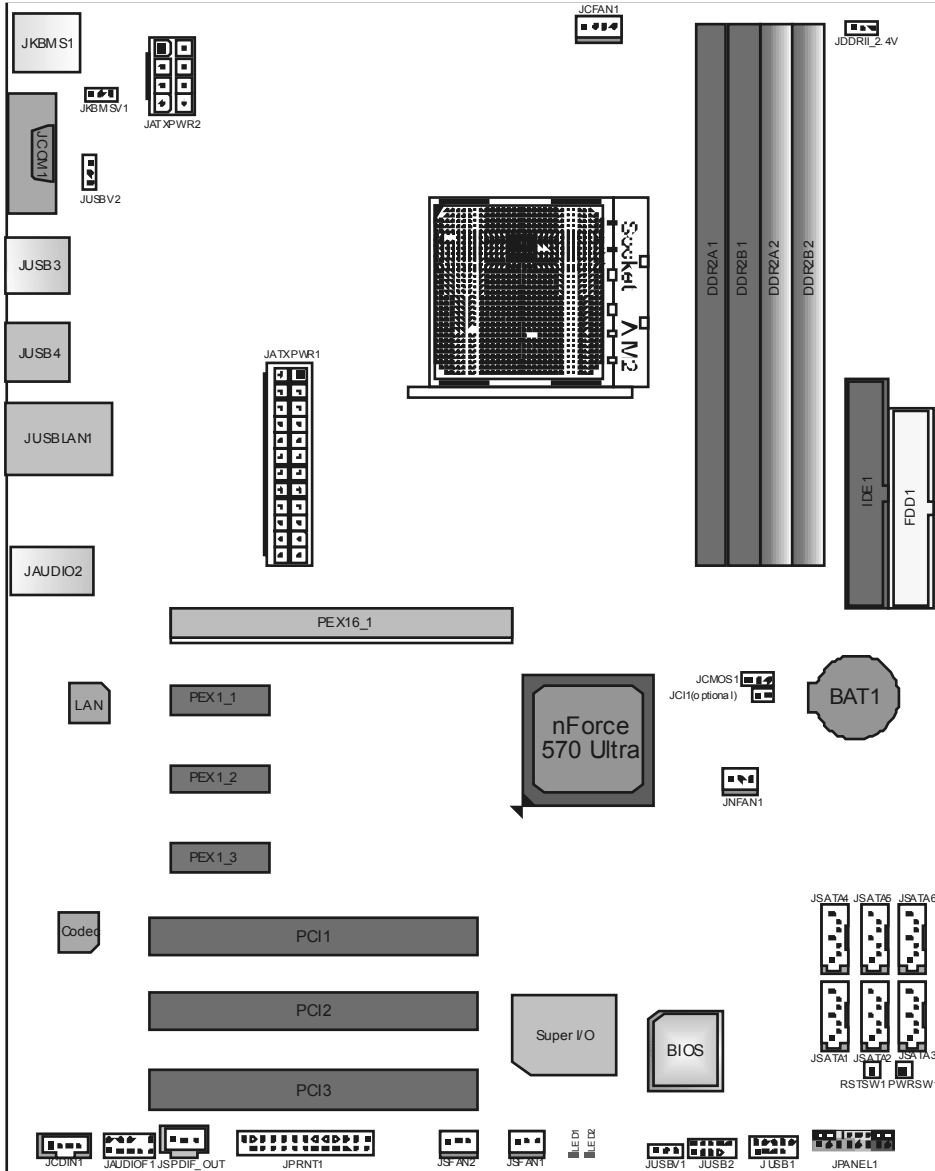

Note: ■ represents the 1st pin.

CHAPTER 2: HARDWARE INSTALLATION

2.1 INSTALLING CENTRAL PROCESSING UNIT (CPU)

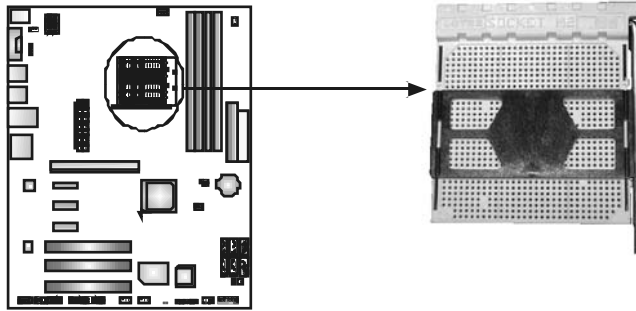

Step 1: Remove the socket protection cap.

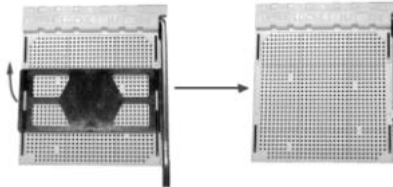

Step 2: Pull the lever toward direction A from the socket and then raise the lever up to a 90-degree angle.

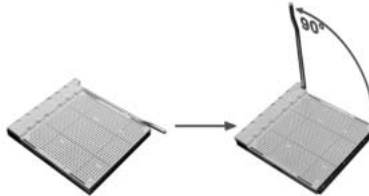

Step 3: Look for the white triangle on socket, and the gold triangle on CPU should point towards this white triangle. The CPU will fit only in the correct orientation.



TForce 570 U

Step 4: Hold the CPU down firmly, and then close the lever toward direct B to complete the installation.

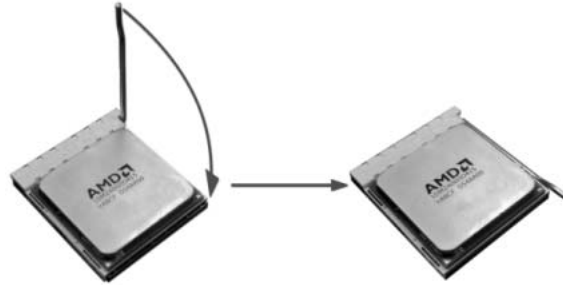

Step 5: Put the CPU Fan on the CPU and buckle it. Connect the CPU FAN power cable to the JCFAN1. This completes the installation.

2.2 FAN HEADERS

These fan headers support cooling-fans built in the computer. The fan cable and connector may be different according to the fan manufacturer. Connect the fan cable to the connector while matching the black wire to pin#1.

JCFAN1: CPU Fan Header

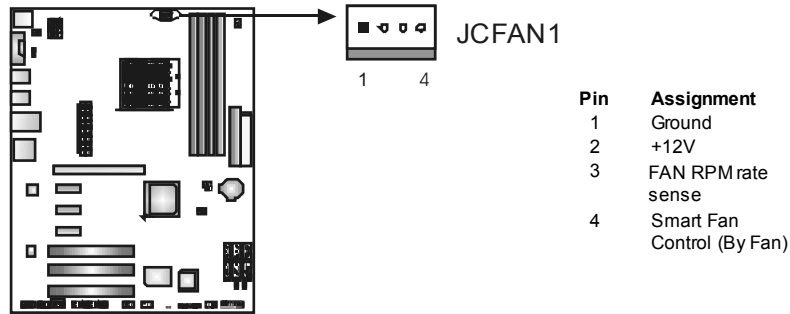

JSFAN1 / JSFAN2: System Fan Header

JNFAN1: North Bridge Fan Header

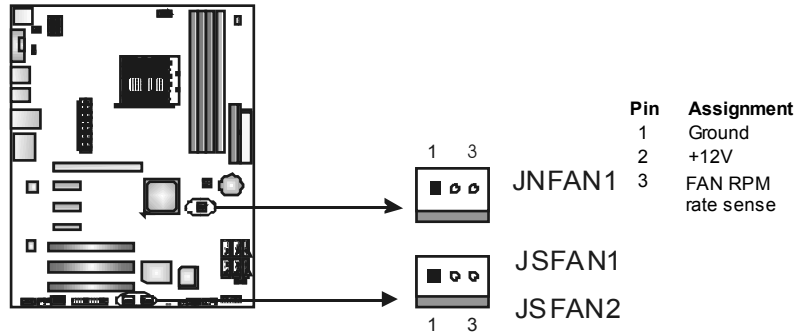

Note:

The JCFAN1、JSFAN1/JSFAN2 and JNFAN1 support 4-pin and 3-pin head connector. When connecting with wires onto connectors, please note that the red wire is the positive and should be connected to pin#2, and the black wire is Ground and should be connected to GND.

2.3 INSTALLING SYSTEM MEMORY

A. Memory Modules

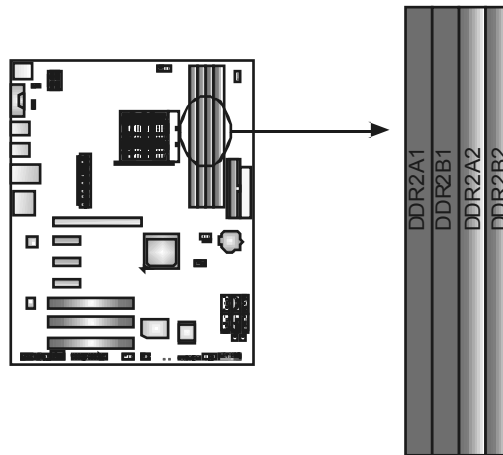

1. Unlock a DIMM slot by pressing the retaining clips outward. Align a DIMM on the slot such that the notch on the DIMM matches the break on the Slot.

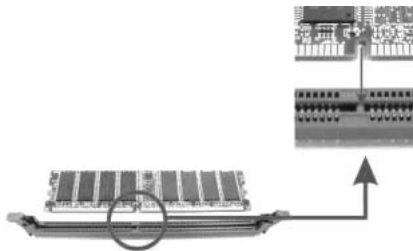

2. Insert the DIMM vertically and firmly into the slot until the retaining chip snap back in place and the DIMM is properly seated.

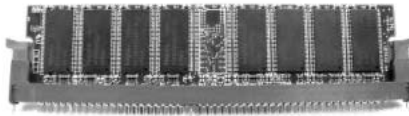

B. Memory Capacity

DIMM Socket Location	DDR Module	Total Memory Size
DDR2A1	256MB/512MB/1024MB	Max is 4GB.
DDR2B1	256MB/512MB/1024MB	
DDR2A2	256MB/512MB/1024MB	
DDR2B2	256MB/512MB/1024MB	

C. Dual Channel Memory installation

To trigger the Dual Channel function of the motherboard, the memory module must meet the following requirements:

Install memory module of the same density in pairs, shown in the following table.

Dual Channel Status	DDR2A1	DDR2B1	DDR2A2	DDR2B2
Enabled	O	O	X	X
Enabled	X	X	O	O
Enabled	O	O	O	O

(O means memory installed, X means memory not installed.)

The DRAM bus width of the memory module must be the same (x8 or x16)

2.4 CONNECTORS AND SLOTS

FDD1: Floppy Disk Connector

The motherboard provides a standard floppy disk connector that supports 360K, 720K, 1.2M, 1.44M and 2.88M floppy disk types. This connector supports the provided floppy drive ribbon cables.

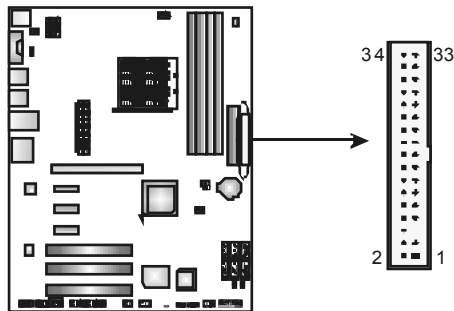

IDE1: Hard Disk Connector

The motherboard has a 32-bit Enhanced IDE Controller that provides PIO Mode 0~4, Bus Master, and Ultra DMA 33/66/100/133 functionality.

The IDE connector can connect a master and a slave drive, so you can connect up to two hard disk drives.

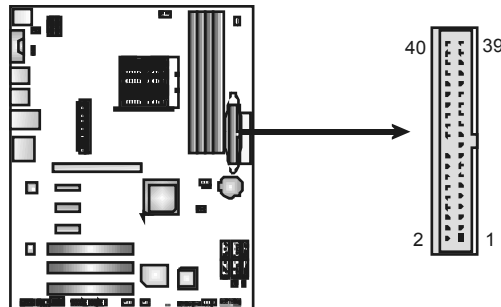

PEX16_1: PCI-Express x16 Slot

- PCI-Express 1.0a compliant.
- Maximum theoretical realized bandwidth of 4GB/s simultaneously per direction, for an aggregate of 8GB/s totally.

PEX1_1/PEX1_2/ PEX1_3: PCI-Express x1 slots

- PCI-Express 1.0a compliant.
- Data transfer bandwidth up to 250MB/s per direction; 500MB/s in total.
- PCI-Express supports a raw bit-rate of 2.5Gb/s on the data pins.
- 2X bandwidth over the traditional PCI architecture.

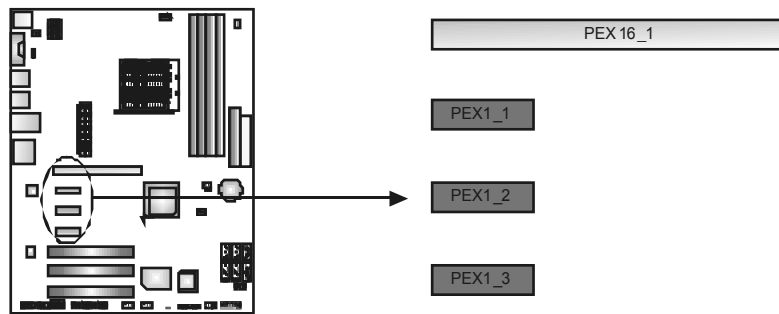

PCI1~PCI3: Peripheral Component Interconnect Slots

This motherboard is equipped with 3 standard PCI slots. PCI stands for Peripheral Component Interconnect, and it is a bus standard for expansion cards. This PCI slot is designated as 32 bits.

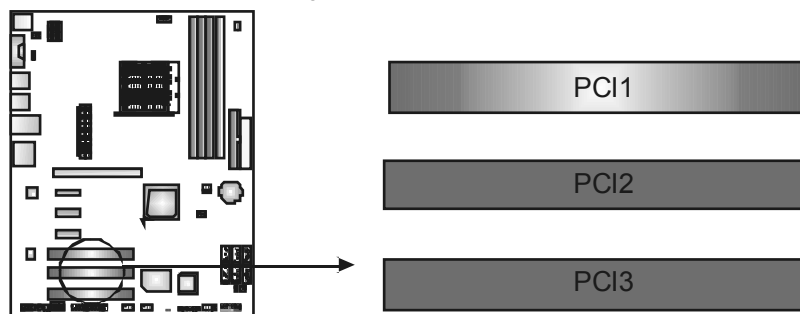

CHAPTER 3: HEADERS & JUMPERS SETUP

3.1 HOW TO SETUP JUMPERS

The illustration shows how to set up jumpers. When the jumper cap is placed on pins, the jumper is “close”, if not, that means the jumper is “open”.



3.2 DETAIL SETTINGS

JPANEL1: Front Panel Header

This 16-pin connector includes Power-on, Reset, HDD LED, Power LED, Sleep button and speaker connection. It allows user to connect the PC case’s front panel switch functions.

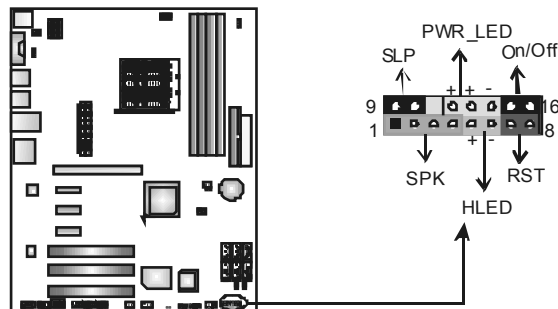

Pin	Assignment	Function	Pin	Assignment	Function
1	+5V	Speaker Connector	9	Sleep control	Sleep button
2	N/A		10	Ground	
3	N/A		11	N/A	N/A
4	Speaker	Hard drive LED	12	Power LED (+)	Power LED
5	HDD LED (+)		13	Power LED (+)	
6	HDD LED (-)		14	Power LED (-)	
7	Ground	Reset button	15	Power button	Power-on button
8	Reset control		16	Ground	

JATXPWR1: ATX Power Source Connector

This connector allows user to connect 24-pin power connector on the ATX power supply.

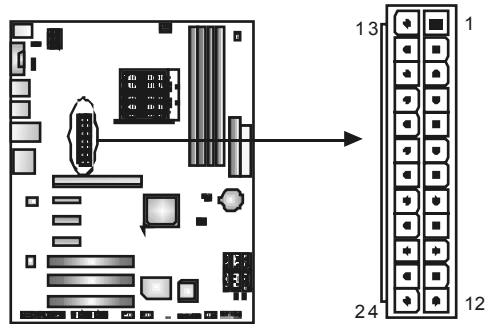

Pin	Assignment	Pin	Assignment
13	+3.3V	1	+3.3V
14	-12V	2	+3.3V
15	Ground	3	Ground
16	PS_ON	4	+5V
17	Ground	5	Ground
18	Ground	6	+5V
19	Ground	7	Ground
20	NC	8	PW_OK
21	+5V	9	Standby Voltage+5V
22	+5V	10	+12V
23	+5V	11	+12V
24	Ground	12	+3.3V

JATXPWR2: ATX Power Source Connector

By connecting this connector, it will provide +12V to CPU power circuit.

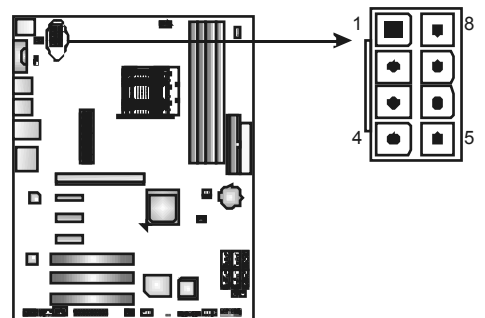

Pin	Assignment
1	+12V
2	+12V
3	+12V
4	+12V
5	Ground
6	Ground
7	Ground
8	Ground

JKBMSV1: Power Source Selection Headers for Keyboard/Mouse

Pin 1-2 Close:

JKBMSV1: +5V for PS/2 key board and mouse.

Pin 2-3 Close:

JKBMSV1: PS/2 keyboard and mouse are powered with +5V standby voltage.

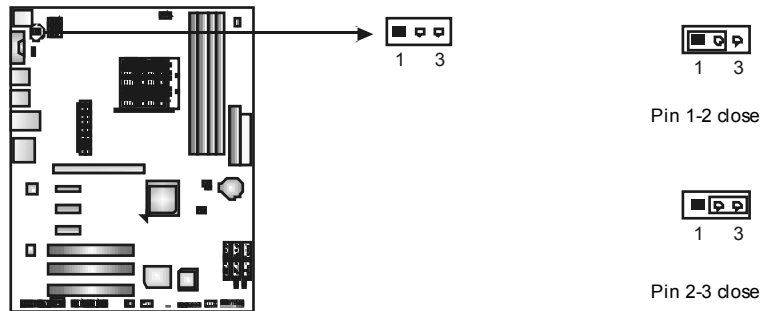

JUSB1/JUSB2: Headers for USB 2.0 Ports at Front Panel

This header allows user to connect additional USB cable on the PC front panel, and also can be connected with internal USB devices, like USB card reader.

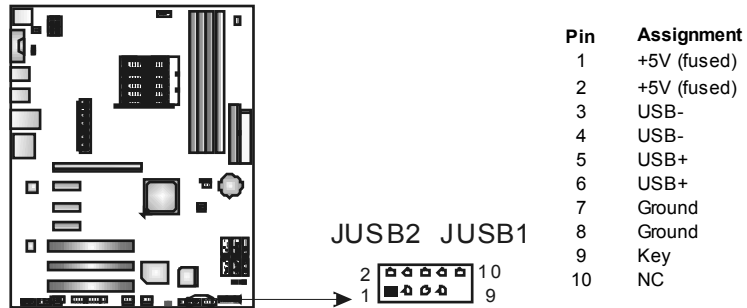

JUSBV1/JUSBV2: Power Source Headers for USB Ports

Pin 1-2 Close:

JUSBV1: +5V for USB ports at JUSBLAN1.

JUSBV2: +5V for USB ports at front panel (JUSB1/JUSB2).

Pin 2-3 Close:

JUSBV1: USB ports at JUSBLAN1 are powered by +5V standby voltage.

JUSBV2: USB ports at front panel (JUSB1/JUSB2) are powered by +5V standby voltage.

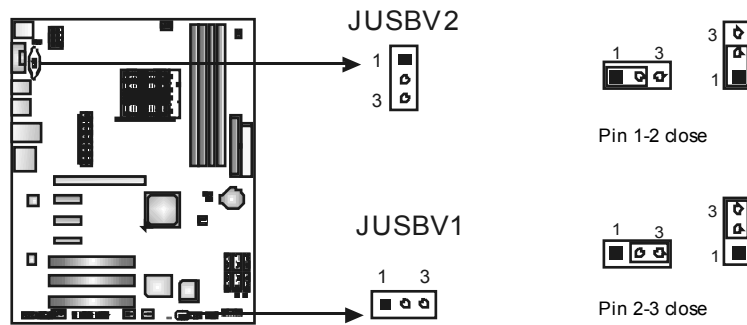

Note:

In order to support this function "Power-On system via USB device," "JUSBV1/ JUSBV2" jumper cap should be placed on Pin 2-3 individually.

JAUDIOF1: Front Panel Audio Header

This header allows user to connect the front audio output cable with the PC front panel. It will disable the output on back panel audio connectors.

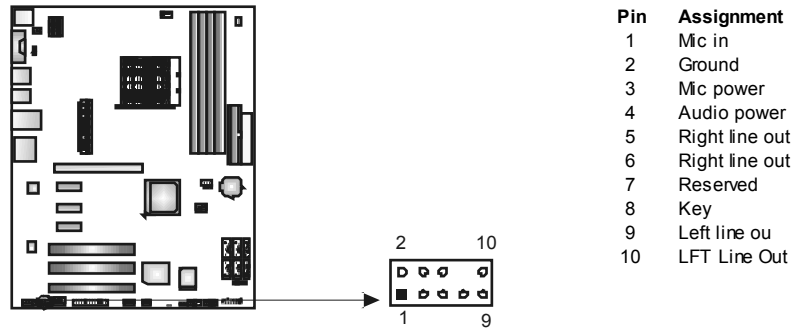

JCDIN1: CD-ROM Audio-in Connector

This connector allows user to connect the audio source from the variety devices, like CD-ROM, DVD-ROM, PCI sound card, PCI TV tuner card etc.

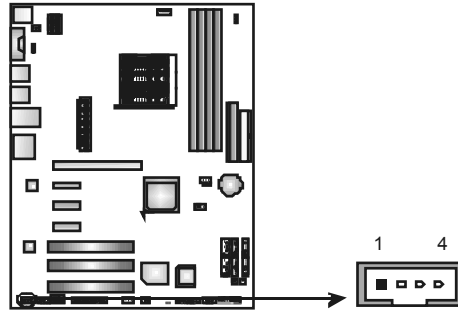

Pin	Assignment
1	Left Channel Input
2	Ground
3	Ground
4	Right Channel Input

JCMOS1: Clear CMOS Header

By placing the jumper on pin2-3, it allows user to restore the BIOS safe setting and the CMOS data, please carefully follow the procedures to avoid damaging the motherboard.

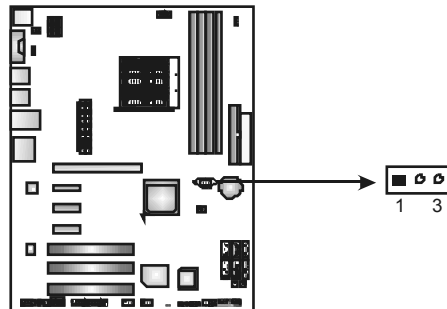

Pin 1-2 Close:
Normal Operation (default).



Pin 2-3 Close:
Clear CMOS data.

※ Clear CMOS Procedures:

1. Remove AC power line.
2. Set the jumper to "Pin 2-3 close".
3. Wait for five seconds.
4. Set the jumper to "Pin 1-2 close".
5. Power on the AC.
6. Reset your desired password or clear the CMOS data.

JCI1: Chassis Open Header (Optional)

This connector allows system to monitor PC case open status. If the signal has been triggered, it will record to the CMOS and show the message on next boot-up.

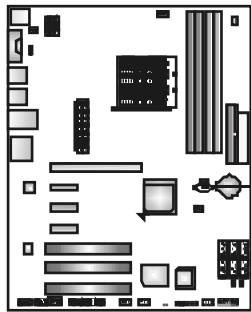

Pin	Assignment
1	Case open signal
2	Ground

JPRNT1: Printer Port Connector

This header allows you to connector printer on the PC.

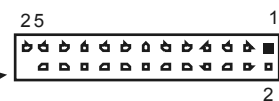
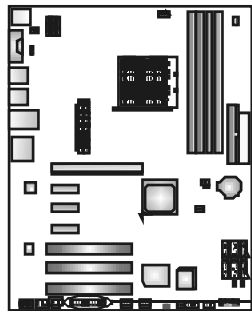

Pin	Assignment	Pin	Assignment
1	-Strobe	14	Ground
2	-ALF	15	Data 6
3	Data 0	16	Ground
4	-Error	17	Data 7
5	Data 1	18	Ground
6	-Init	19	-ACK
7	Data 2	20	Ground
8	-Scltin	21	Busy
9	Data 3	22	Ground
10	Ground	23	PE
11	Data 4	24	Ground
12	Ground	25	SCLT
13	Data 5	26	Key

JSATA1~JSATA6: Serial ATA Connectors

The motherboard has a PCI to SATA Controller with 6 channels SATA interface, it satisfies the SATA 2.0 spec and with transfer rate of 3.0Gb/s.

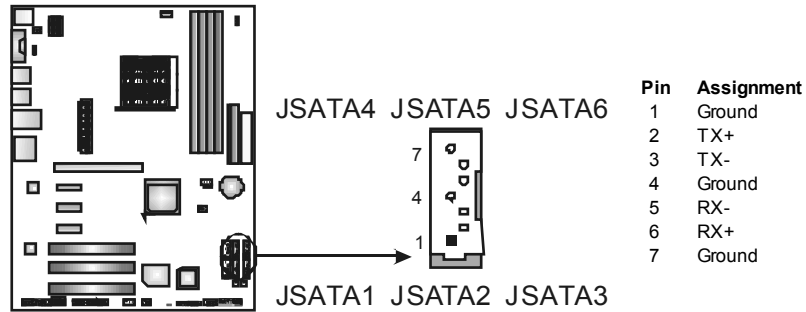

Header for Memory over-voltage: JDDRII_2.2V (for Ver 1.x)

When processing Memory over-voltage, please place the jumper to pin2-3 Closed. The Default setting is Pin 1-2 Closed.

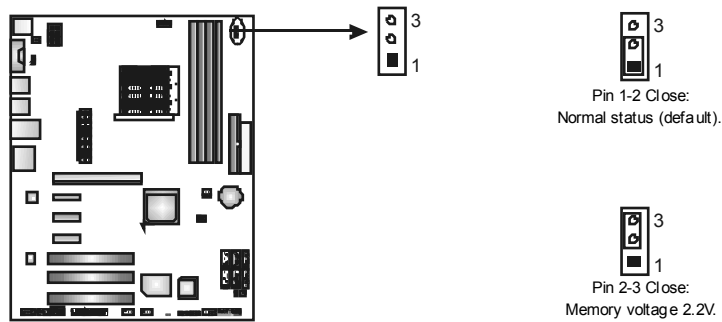

Note:

1. When “JDDRII_2.2V” jumper cap is placed on Pin 1-2, memory voltage can be manually adjusted in CMOS setup screen.
2. When “JDDRII_2.2V” jumper cap is placed on Pin 2-3, memory voltage will be fixed at 2.2V automatically, and can't be adjusted under COMS setup.

Before setting memory over-voltage, please ensure that your DDR2 supports up to 2.2V. (Consult your DDR2 supplier)

Header for Memory over-voltage: JDDRII_2.4V (for Ver 5.x/6.x)

When processing Memory over-voltage, please place the jumper to pin2-3 Closed. The Default setting is Pin 1-2 Closed.

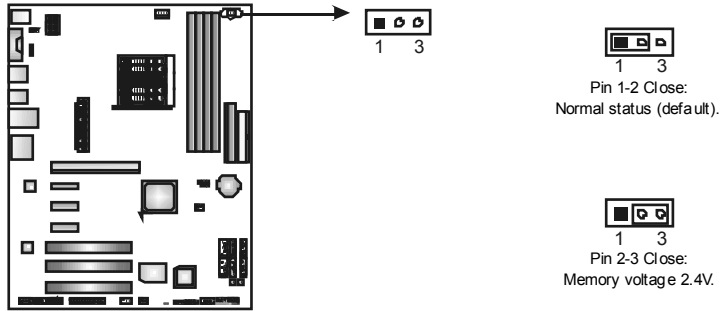

Note:

3. When “JDDRII_2.4V” jumper cap is placed on Pin 1-2, memory voltage can be manually adjusted in CMOS setup screen.
4. When “JDDRII_2.4V” jumper cap is placed on Pin 2-3, memory voltage will be fixed at 2.4V automatically, and can't be adjusted under COMS setup.

Before setting memory over-voltage, please ensure that your DDR2 supports up to 2.4V. (Consult your DDR2 supplier)

On-Board LED Indicators

There are 2 LED indicators on the motherboard to show system status.

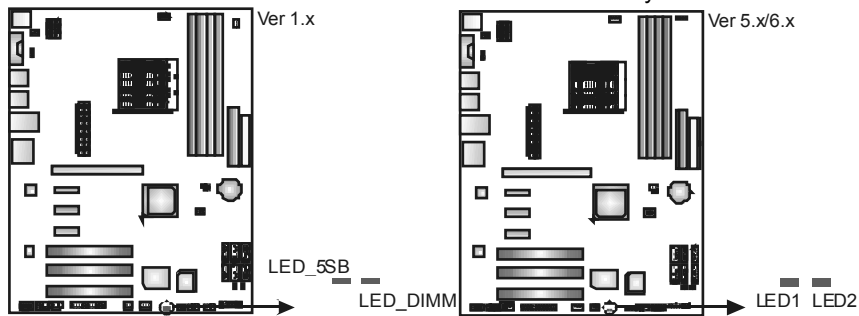

LED_DIMM:

This LED indicates the voltage of memory is activated normally.

LED_5SB:

This LED indicates the system is ready for Power-on.

LED1 and LED2:

These 2 LED indicate system power on diagnostics.
Please refer to the table below for different messages:

LED1	LED2	Message
ON	ON	Normal
ON	OFF	VGA Error
OFF	ON	Memory Error
OFF	OFF	Abnormal: CPU / Chipset error

On-Board Buttons

There are 2 on-board buttons.

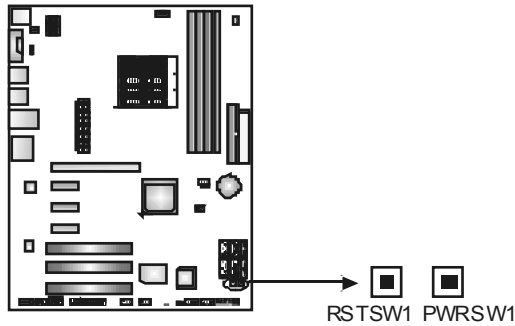

PWRSW1:

This is an on-board Power Switch button.

RSTSW1:

This is an on-board Reset button.

JSPDIF_OUT1: Digital Audio-out Connector

This connector allows user to connect the PCI bracket SPDIF output header.

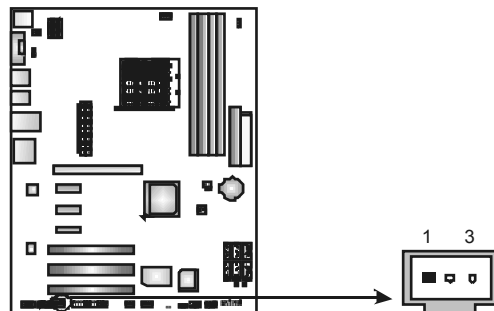

Pin	Assignment
1	+5V
2	SPDIF_OUT
3	Ground

CHAPTER 4: NVIDIA RAID FUNCTIONS

4.1 OPERATION SYSTEM

Supports Windows XP Home/Professional Edition, and Windows 2000 Professional.

4.2 RAID ARRAYS

NVRAID supports the following types of RAID arrays:

RAID 0: RAID 0 defines a disk striping scheme that improves disk read and write times for many applications.

RAID 1: RAID 1 defines techniques for mirroring data.

RAID 0+1: RAID 0+1 combines the techniques used in RAID 0 and RAID 1.

Spanning (JBOD): JBOD provides a method for combining drives of different sizes in to one large disk.

RAID 5: RAID 5 provides fault tolerance and better utilization of disk capacity.

4.3 How RAID WORKS

RAID 0:

The controller “stripes” data across multiple drives in a RAID 0 array system. It breaks up a large file into smaller blocks and performs disk reads and writes across multiple drives in parallel. The size of each block is determined by the stripe size parameter, which you set during the creation of the RAID set based on the system environment. This technique reduces overall disk access time and offers high bandwidth.

Features and Benefits

- **Drives:** Minimum 1, and maximum is up to 6 or 8. Depending on the platform.
- **Uses:** Intended for non-critical data requiring high data throughput, or any environment that does not require fault tolerance.
- **Benefits:** provides increased data throughput, especially for large files. No capacity loss penalty for parity.
- **Drawbacks:** Does not deliver any fault tolerance. If any drive in the array fails, all data is lost.
- **Fault Tolerance:** No.

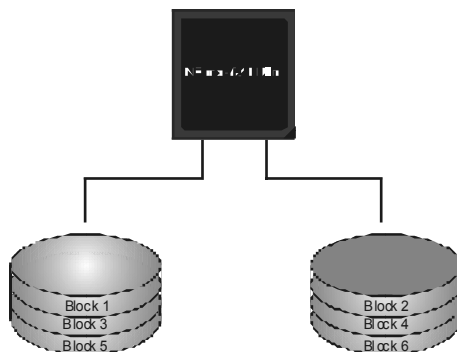

RAID 1:

Every read and write is actually carried out in parallel across 2 disk drives in a RAID 1 array system. The mirrored (backup) copy of the data can reside on the same disk or on a second redundant drive in the array. RAID 1 provides a hot-standby copy of data if the active volume or drive is corrupted or becomes unavailable because of a hardware failure.

RAID techniques can be applied for high-availability solutions, or as a form of automatic backup that eliminates tedious manual backups to more expensive and less reliable media.

Features and Benefits

- **Drives:** Minimum 2, and maximum is 2.
- **Uses:** RAID 1 is ideal for small databases or any other application that requires fault tolerance and minimal capacity.
- **Benefits:** Provides 100% data redundancy. Should one drive fail, the controller switches to the other drive.
- **Drawbacks:** Requires 2 drives for the storage space of one drive. Performance is impaired during drive rebuilds.
- **Fault Tolerance:** Yes.

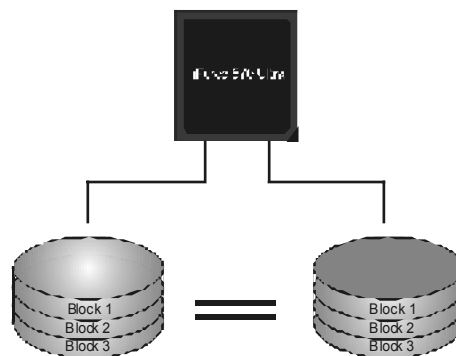

RAID 0+1:

RAID 0 drives can be mirrored using RAID 1 techniques. Resulting in a RAID 0+1 solution for improved performance plus resiliency.

Features and Benefits

- **Drives:** Minimum 4, and maximum is 6 or 8, depending on the platform.
- **Benefits:** Optimizes for both fault tolerance and performance, allowing for automatic redundancy. May be simultaneously used with other RAID levels in an array, and allows for spare disks.
- **Drawbacks:** Requires twice the available disk space for data redundancy, the same as RAID level 1.
- **Fault Tolerance:** Yes.

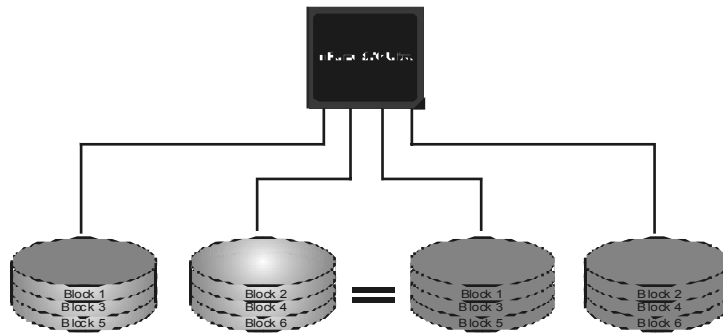

Spanning (JBOD):

JBOD stands for “Just a Bunch of Disks”. Each drive is accessed as if it were on a standard SCSI host bus adapter. This is useful when a single drive configuration is needed, but it offers no speed improvement or fault tolerance.

Features and Benefits

- **Uses:** JBOD works best if you have odd sized drives and you want to combine them to make one big drive.
- **Benefits:** JBOD provides the ability to combine odd size drives using all of the capacity of the drives.
- **Drawbacks:** Decreases performance because of the difficulty in using drives concurrently.
- **Fault Tolerance:** Yes.

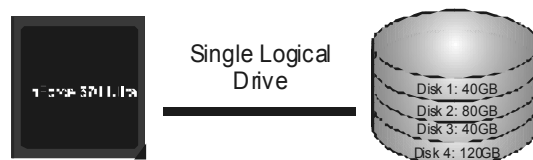

RAID 5:

RAID 5 stripes both data and parity information across three or more drives. It writes data and parity blocks across all the drives in the array. Fault tolerance is maintained by ensuring that the parity information for any given block of data is placed on a different drive from those used to store the data itself.

Features and Benefits

- **Drives: Minimum 3.**
- **Uses: RAID 5 is recommended for transaction processing and general purpose service.**
- **Benefits: An ideal combination of good performance, good fault tolerance, and high capacity and storage efficiency.**
- **Drawbacks: Individual block data transfer rate same as a single disk. Write performance can be CPU intensive.**
- **Fault Tolerance: Yes.**

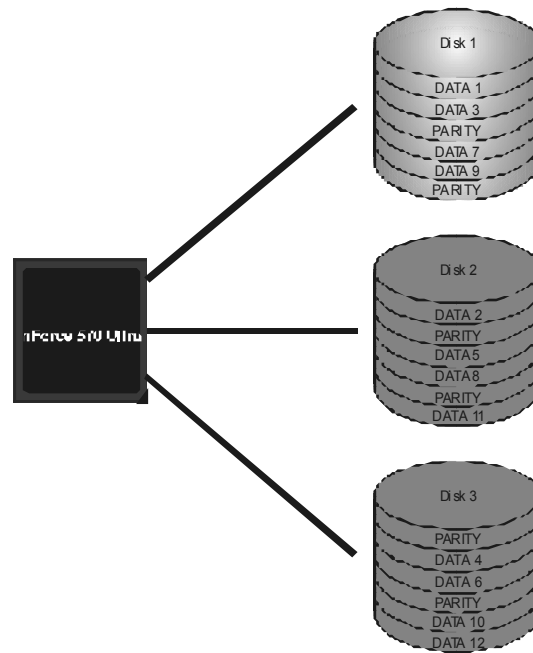

※ For more detailed setup information, please refer to the Driver CD, or go to http://www.nvidia.com/page/pg_20011106217193.html to download NVIDIA nForce Tutorial Flash.

CHAPTER 5: OVERCLOCK QUICK GUIDE

5.1 T-POWER INTRODUCTION

Biostar T-Power is a whole new utility that is designed for overclock users. Based on many precise tests, *Biostar Engineering Team* (BET) has developed this ultimate overclock engine to raise system performance. No matter whether under BIOS or Windows interface, *T-Power* is able to present the best system state according to users' overclock setting.

T-Power BIOS Features:

- Overclocking Navigator Engine (O.N.E.)
- CMOS Reloading Program (C.R.P.)
- Memory Integration Test (M.I.T., under Overclock Navigator Engine)
- Integrated Flash Program (I.F.P.)
- Smart Fan Function (under PC Health Status)
- Self Recovery System (S.R.S)

T-Power Windows Feature:

- Hardware Monitor
- Overclock Engine
- Smart Fan Function
- Life Update

5.2 T-POWER BIOS FEATURE

A. Overclocking Navigator Engine (O.N.E.):

ONE provides two powerful overclocking engines: MOS and AOS for both Elite and Casual overclockers.



Manual Overclock System (M.O.S.)

MOS is designed for experienced overclock users.

It allows users to customize personal overclock settings.



CPU Overclock Setting:

CPU Voltage:

This function will increase CPU stability when overclocking. However, the CPU temperature will increase when CPU voltage is increased.

Choices: The range is from 1.2V to 1.725V, with an interval of 0.025V.

CPU Frequency:

CPU Frequency is directly in proportion to system performance. To maintain the system stability, CPU voltage needs to be increased also when raising CPU frequency.

Choices: This range is from 200 to 450, with an interval of 1MHz.

Hammer CPU Multiplier:

The MOS allows users to downgrade the CPU ratio when overclocking.

Choices: The lower limit is x4 (800MHz). The upper limit is decided by different CPU type. With an x1 (200MHz) interval.

Memory Overclock Setting:

Memory Voltage:

This function will increase memory stability when overclocking.

Choices: The range is from 1.85V to 2.0V, with an interval of 0.05V.

Memclock Frequency:

To get better system performance, sometimes downgrading the memory frequency is necessary when CPU frequency is adjusted over the upper limit.

Choices: DDR2 400, DDR2 533, DDR2 667, DDR2 800 (MHz).

PCI-Express Overclock Setting:

PCIe Clock:

It helps to increase VGA card performance.

Choices: The range is from 100 to 145, with an interval of 1MHz.

Chipset Overclock Setting:

NB/SB Voltage Regulator:

This function will increase chipset stability when overclocking.

Choices: 1.52V, 1.60V, 1.68V, 1.76V.

HT Frequency:

We recommend users to set this item at "x4" when overclocking.

Choices: x1, x2, x3, x4, x5, Auto.

Automatic Overclock System (A.O.S.)

For beginners in overclock field, BET had developed an easy, fast, and powerful feature to increase the system performance, named A.O.S. Based on many tests and experiments, A.O.S. provides 3 ideal overclock configurations that are able to raise the system performance in a single step.



V6 Tech Engine:

This setting will raise about 10%~15% of whole system performance.



V8 Tech Engine:

This setting will raise about 15%~25% of whole system performance.



V12 Tech Engine:

This setting will raise about 25%~30% of whole system performance.



- Notices:**
1. Not all types of AMD CPU perform above overclock setting ideally; the difference will be based on the selected CPU model.
 2. From BET experiments, the Atholon64 FX CPU is not suitable for this A.O.S. feature.

B. CMOS Reloading Program (C.R.P.):

It allows users to save different CMOS settings into BIOS-ROM.

Users are able to reload any saved CMOS setting for customizing system configurations.

Moreover, users are able to save an ideal overclock setting during overclock operation.

There are 50 sets of record addresses in total, and users are able to name the CMOS data according to personal preference.



C. Memory Integration Test (M.I.T.):

This function is under "Overclock Navigator Engine" item. MIT allows users to test memory compatibilities, and no extra devices or software are needed.

Step 1:

The default setting under this item is "Disabled", the condition parameter should be changed to "Enable" to proceed this test.

```
Phoenix - Award WorkstationBIOS CMOS Setup Utility (CRU51-AM2)
OverClock Navigator Engine

Overclock Navigator [Automate Overclock]
----- Automate Overclock System -----
Auto Overclock System [U6 -Tech Engine]
----- Manual Overclock System -----
** CPU Spec Voltage ** 1.350V
** NB/SB Spec Voltage ** 1.52V
** HT Spec Voltage ** 1.23V
** Memory Spec Voltage ** 2.60V
x CPU Voltage StartUp
x NB/SB Voltage Regulator 1.52V
x HT Voltage Regulator 1.23V
x Memory Voltage 2.60V

x CPU Frequency 200
x HT Frequency Auto
x PCIE Clock 100Mhz
x DRAM Configuration Press Enter
Watch dog times(times) [3]
Integated Memory Test [Disabled]

↑↓←→:Move Enter:Select +/-/PU/PD:Value F10:Save ESC:Exit F1:General Help
F5:Previous Values F7: Optimized Defaults
```

```
Phoenix - Award WorkstationBIOS CMOS Setup Utility (CRU51-AM2)
OverClock Navigator Engine

Overclock Navigator [Automate Overclock]
----- Automate Overclock System -----
Auto Overclock System [U6 -Tech Engine]
----- Manual Overclock System -----
** CPU Spec Voltage ** 1.350V
** NB/SB Spec Voltage ** 1.52V
** HT Spec Voltage ** 1.23V
** Memory Spec Voltage ** 2.60V
x CPU Voltage StartUp
x NB/SB Voltage Regulator 1.52V
x HT Voltage Regulator 1.23V
x Memory Voltage 2.60V

x CPU Frequency 200
x HT Frequency Auto
x PCIE Clock 100Mhz
x DRAM Configuration Press Enter
Watch dog times(times) [3]
Integated Memory Test [Enabled]

↑↓←→:Move Enter:Select +/-/PU/PD:Value F10:Save ESC:Exit F1:General Help
F5:Previous Values F7: Optimized Defaults
```

Step 2:

Save and Exit from CMOS setup and reboot the system to activate this test. Run this test for 5 minutes (minimum) to ensure the memory stability.

Step 3:

When the process is done, change the setting back from "Enable" to "Disable" to complete the test.

D. Self Recovery System (S.R.S.):

This function can't be seen under T-Power BIOS setup; and is always on whenever the system starts up.

However, it can prevent system hang-up due to inappropriate overclock actions.

When the system hangs up, S.R.S. will automatically log in the default BIOS setting, and all overclock settings will be re-configured.

E. Integrated Flash Program (I.F.P.):

IFP is a safe and quick way to upgrade BIOS.

Step 1:

Go to Biostar website (<http://www.biostar.com.tw>) to download the latest BIOS file. Then, save the file into a floppy disk.

Step 2:

Insert the floppy disk and reboot the system to get into CMOS screen.

Step 3:

Select the item "Integrated Flash Program" to get the following frame and choose the BIOS file downloaded in step 1.



Step 4:

Press "Enter" key to start BIOS file loading, and BIOS updating will process automatically.

Step 5:

When the BIOS update is completed, press YES to the message "Flash done, Reset system", and the system will reboot automatically to finish the process.

Advise:

You can update the system BIOS by simply pressing "Enter" key for three times.

F. Smart Fan Function:

Smart Fan Function is under "PC Health Status".

This is a brilliant feature to control CPU Temperature vs. Fan speed.

When enabling Smart Fan function, Fan speed is controlled automatically by CPU temperature.

This function will protect CPU from overheat problem and maintain the system temperature at a safe level.

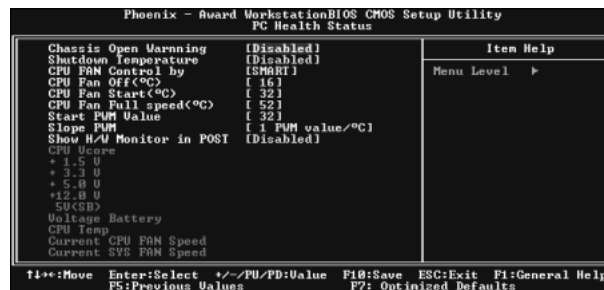

CPU Fan Off <°C>:

If the CPU temperature is lower than the set value, the CPU fan will turn off. The range is from 0°C ~127°C, with an interval of 1°C.

CPU Fan Start <°C>

The CPU fan starts to work when CPU temperature arrives to this set value. The range is from 0°C ~127°C, with an interval of 1°C.

CPU Fan Full speed <°C>

When CPU temperature arrives to the set value, the CPU fan will work under Full Speed. The range is from 0°C ~127°C, with an interval of 1°C.

Start PWM Value

When CPU temperature arrives to the set value, the CPU fan will work under Smart Fan Function mode. The range is from 0~127, with an interval of 1.

Slope PWM

Choices: 1 PWM Value/°C (default), 2 PWM Value/°C , 4 PWM Value/°C , 8 PWM Value/°C , 16 PWM Value/°C , 32 PWM Value/°C , 64 PWM Value/°C .

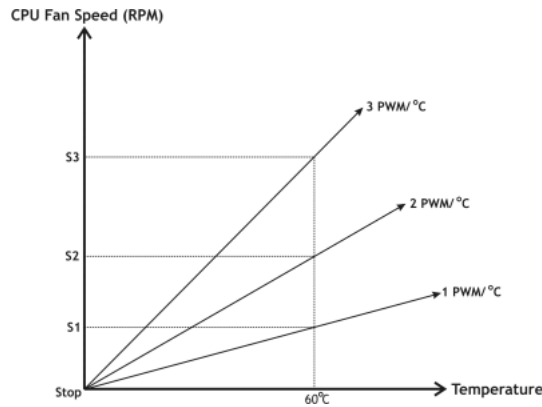

S1: CPU temperature is 60°C, and PWM value is 1 PWM/°C .

S2: CPU temperature is 60°C, and PWM value is 2 PWM/°C .

S3: CPU temperature is 60°C, and PWM value is 3 PWM/°C .

Increasing the value of slope PWM will raise the speed of CPU fan.

As in above diagram, when the CPU temperature reaches 60°C, the CPU fan speed for 3 PWM/°C is higher than 1 PWM/°C (S1<S2<S3).

5.3 T-POWER WINDOWS FEATURE

A. Hardware Monitor:

T-Power Hardware monitor allows users to monitor system voltage, temperature and fan speed accordingly. Additionally, a rescue action will be taken by the program automatically while the system faces an abnormal condition. The program will trigger an alarm or shut down the system when unpredictable errors occur. All the monitoring items are illustrated by a waveform diagram.

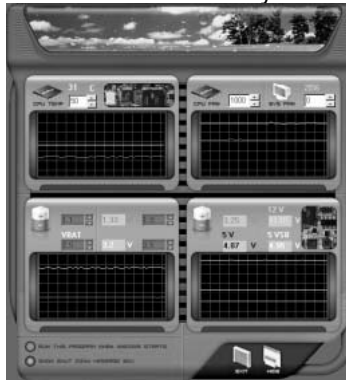

Hardware Monitor Toolbar



i. Start-up Setting

Click on this item to run Hardware Monitor Program when the Windows starts-up.

ii. Dialogue-Box Setting

Click on this item to pop-up warning dialogue-box when PC system is abnormal.

iii. Exit

Click on this item to exit Hardware Monitor Program.

iv. Hide

Click on this item to hide this program in system tray. When hiding the program, there will be a check icon in the system tray.



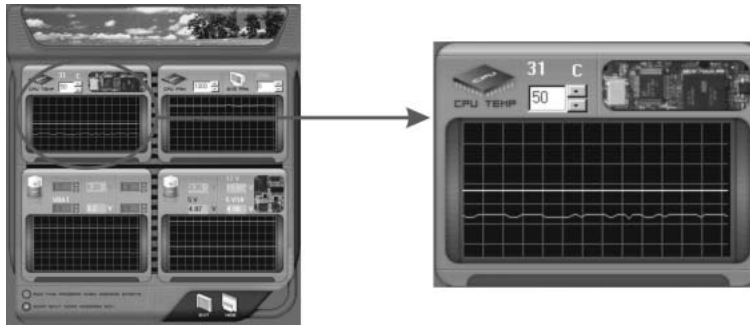

CPU Temperature

This column configures the CPU temperature. There is a waveform to represent the status of CPU temperature.



By adjusting , users can easily configure the upper limit of CPU temperature for system operating.

In this diagram, the white line represents the upper limit which user-set for CPU temperature and the green line shows present CPU temperature.

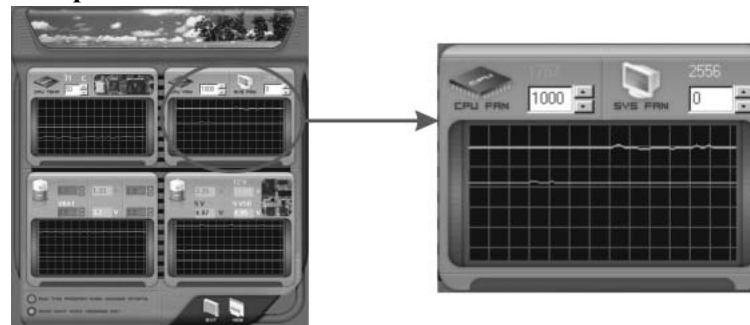

If the CPU temperature is higher than the upper limit, the status line color will change from green to red, and a warning sound will alert you. Also, the system tray icon  would change to .

FAN Speed



By adjusting , users can easily configure the lower limit of the fan speed.

In this diagram, the green line shows present CPU Fan speed, and the yellow line shows System Fan speed (if any).

If any one of the fans speeds is lower than the set value, the status line will change into a red warning line, and the program will trigger an alarm system automatically. Also, the system tray icon  would change to .

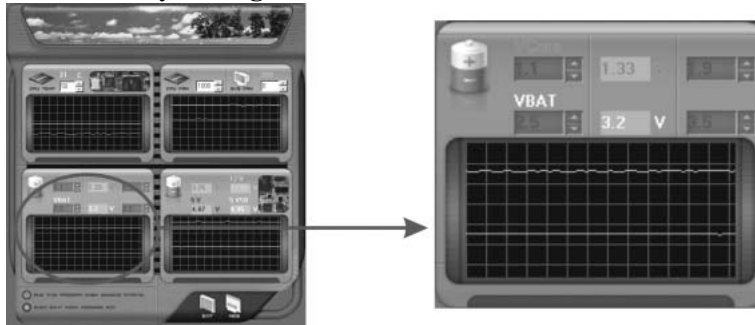

CPU/Battery Voltage



i. VCore

This item displays the CPU voltage, represented by a light blue line.



Users can set the upper and lower limit by adjusting  to monitor the CPU operating voltage.

If CPU voltage is higher or lower than the set value, the status line will change into a red warning line, and a warning sound will alert you. Also, the system tray icon  will change to .

ii. VBAT

This item displays the CMOS battery voltage, represented by a light green line.

Users can set the upper and lower limit by adjusting  to monitor the status of battery voltage.

If battery voltage is higher or lower than the set value, the status line will change to a red warning line, and a warning sound will alert you. Also, the system tray icon  will change to .

Reference data

This column represents the status of power supply voltage and cannot be adjusted, it is only for present status reference.

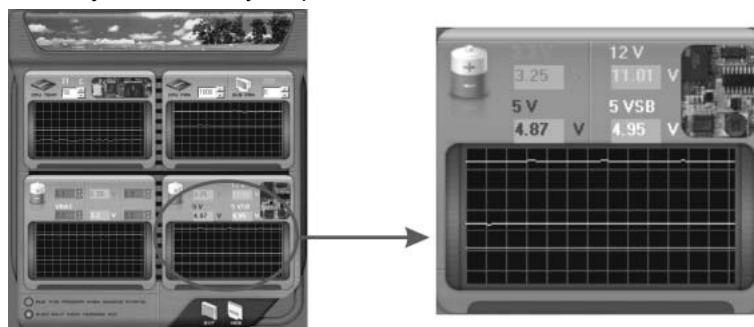

B. Overclocking Configurations

This diagram is designed for T-series Overclocking utility. Friendly interface and solid overclock features are the major concept of this utility.

Graphic 1 will appear when activating this utility.



Graphic 1

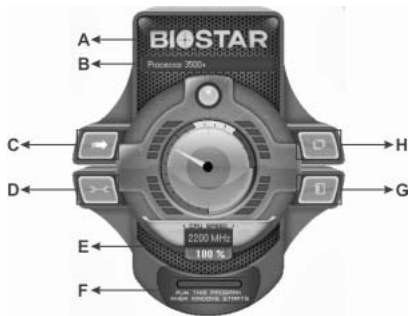

Graphic 2

- A. Clicking on “Biostar” will lead you to the Biostar Homepage.
- B. This column shows the CPU speed information.
- C. Click on this button and the utility will pop-up 4 sub-screens (Please refer to Graphic 3).
- D. Click on this button to minimize this program to taskbar.
- E. This column shows present CPU speed and overclocking percentage.
- F. Clicking on this button will make the program start up as soon as the Windows starts up.
- G. Click on this button to exit this overclock utility.
- H. Click on this button to reset all the overclock features to default setting.

By adjusting the overclocking features in 4 sub-screens, users can tune the system performance to an optimal level.

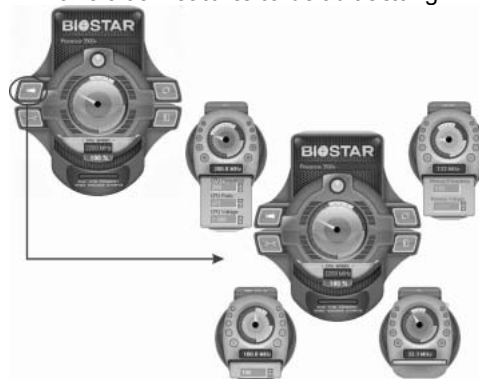

Graphic 3

CPU Overclocking Settings:

By adjusting  can configure three items for CPU overclocking.

- A. CPU Frequency**
Range: 200MHz~450MHz.
Interval: 1MHz.
- B. CPU Ratio**
Range: 4~ 25.
Interval: 1.
- C. CPU Voltage**
Range: 0.8V~ 2.0V.
Interval: 0.0125V.

Memory Overclocking Settings:

By adjusting  can configure two items for Memory overclocking.

- A. Memory Clock Frequency**
Choices: 100, 133, 200, 266, 333, 400, 533, 667, 800.
- B. Memory Voltage**
Range: 1.8V~ 2.8V.
Interval: 0.1V.

AGP/PCI-Express Overclocking Setting:

By adjusting  can configure VGA card overclocking. And this function helps to increase VGA card performance.

- Range: 100MHz~150MHz.
- Interval: 1MHz.

PCI Overclocking Setting:



This diagram shows present PCI working status and helps to monitor PCI peripherals working status.

This item cannot be adjusted.

C. Smart Fan Function

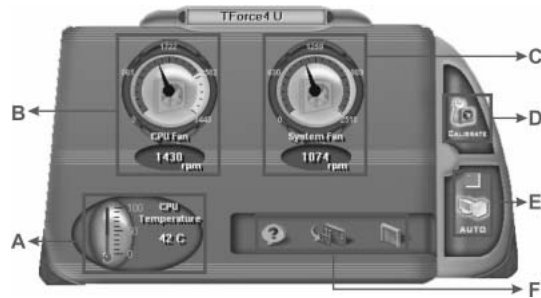

When Smart Fan Function is activated, screens will pop-up to illustrate the fan speed information.

i. CPU Temperature:

Show current CPU temperature.

ii. CPU Fan speed:

Show current CPU Fan speed.

iii. System Fan speed:

Show current system Fan speed.

iv. Calibrate:

When changing CPU Fan or System Fan, click on this button to re-calibrate the Fan speed.

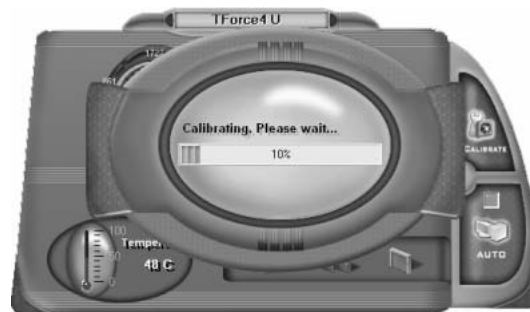

Note:

1. When Smart Fan Function activates for the first time, this calibrate function would auto-run to get upper and lower limitation of CPU Fan and System Fan.
2. When calibrating process is done, the calibrating window will auto-close, and the main screen will show new fan speed data.

v. Auto:



If the green indicator is lit up, the Smart Fan Function is “On” (Default Setting).

Click on this button again to close Smart Fan Function, and a screen as below would pop-up.

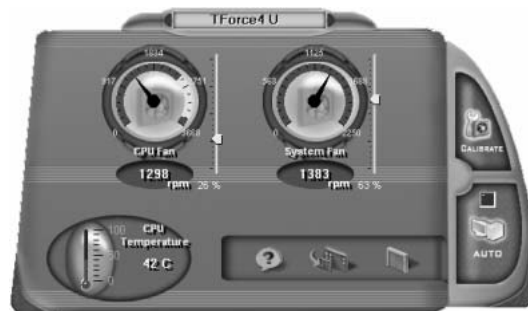
There will be pulling-meter besides the CPU Fan and System Fan, the CPU Fan and the System Fan speed can be adjusted by adjusting the Cursor Up or Down.



vi. Program Tool Bar:

-  **About:**
Click on this button to get program-related information.
-  **Minimize:**
Click on this button to minimize the program to system tray
-  **Exit:**
Click on this button to exit this program.

D. Live Update



When Live Update program is activated, a screen will pop up to illustrate BIOS related information.

i. Link to Internet:

Click on this button will link to Biostar website and BIOS file will be downloaded.

ii. Update BIOS:

Click on this button to run BIOS flashing process, and it's easy and safe.

iii. Backup BIOS:

Click on this button, and BIOS file will be saved into the user-selected folder.

iv. Clear CMOS:

Click on this item will clear the CMOS Data. When carrying this job, the previous CMOS data would be cleared and returned to default setting.

CHAPTER 6: USEFUL HELP

6.1 DRIVER INSTALLATION NOTE

After you installed your operating system, please insert the Fully Setup Driver CD into your optical drive and install the driver for better system performance.

You will see the following window after you insert the CD

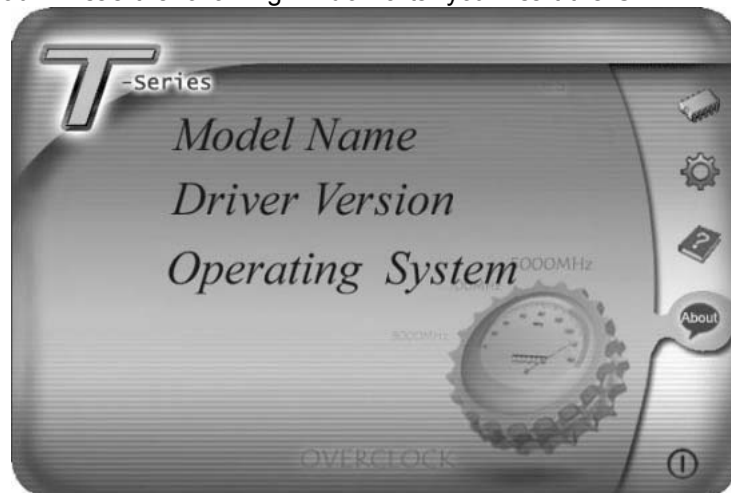

The setup guide will auto detect your motherboard and operating system.

Note:

If this window didn't show up after you insert the Driver CD, please use file browser to locate and execute the file **SETUP.EXE** under your optical drive.

A. Driver Installation

To install the driver, please click on the Driver icon. The setup guide will list the compatible driver for your motherboard and operating system. Click on each device driver to launch the installation program.

B. Software Installation

To install the software, please click on the Software icon. The setup guide will list the software available for your system, click on each software title to launch the installation program.

C. Manual

Aside from the paperback manual, we also provide manual in the Driver CD. Click on the Manual icon to browse for available manual.

Note:

You will need Acrobat Reader to open the manual file. Please download the latest version of Acrobat Reader software from <http://www.adobe.com/products/acrobat/readstep2.html>

6.2 AWARD BIOS BEEP CODE

Beep Sound	Meaning
One long beep followed by two short beeps	Video card not found or video card memory bad
High-low siren sound	CPU overheated System will shut down automatically
One Short beep when system boot-up	No error found during POST
Long beeps every other second	No DRAM detected or install

6.3 EXTRA INFORMATION

A. BIOS Update

After you fail to update BIOS or BIOS is invaded by virus, the Boot-Block function will help to restore BIOS. If the following message is shown after boot-up the system, it means the BIOS contents are corrupted.

```
BIOS ROM checksum error
Detecting floppy drive A media...
INSERT SYSTEM DISK AND PRESS ENTER
```

In this Case, please follow the procedure below to restore the BIOS:

1. Make a bootable floppy disk.
2. Download the Flash Utility "AWDFLASH.exe" from the Biostar website: www.biostar.com.tw
3. Confirm motherboard model and download the respectively BIOS from Biostar website.
4. Copy "AWDFLASH.exe" and respectively BIOS into floppy disk.
5. Insert the bootable disk into floppy drive and press Enter.
6. System will boot-up to DOS prompt.
7. Type "*Awdflash xxxx.bf/sn/py/r*" in DOS prompt.
(xxxx means BIOS name.)
8. System will update BIOS automatically and restart.
9. The BIOS has been recovered and will work properly.

B. CPU Overheated

If the system shutdown automatically after power on system for seconds, that means the CPU protection function has been activated.

When the CPU is over heated, the motherboard will shutdown automatically to avoid a damage of the CPU, and the system may not power on again.

In this case, please double check:

1. The CPU cooler surface is placed evenly with the CPU surface.
2. CPU fan is rotated normally.
3. CPU fan speed is fulfilling with the CPU speed.

After confirmed, please follow steps below to relief the CPU protection function.

1. Remove the power cord from power supply for seconds.
2. Wait for seconds.
3. Plug in the power cord and boot up the system.

Or you can:

1. Clear the CMOS data.
(See "Close CMOS Header: JCMOS1" section)
2. Wait for seconds.
3. Power on the system again.

6.4 TROUBLESHOOTING

Probable	Solution
<ol style="list-style-type: none"> No power to the system at all. Power light don't illuminate, fan inside power supply does not turn on. Indicator light on key board does not turn on. 	<ol style="list-style-type: none"> Make sure power cable is securely plugged in. Replace cable. Contact technical support.
System inoperative. Keyboard lights are on, power indicator lights are lit, and hard drive is spinning.	Using even pressure on both ends of the DIMM, press down firmly until the module snaps into place.
System does not boot from hard disk drive, can be booted from optical drive.	<ol style="list-style-type: none"> Check cable running from disk to disk controller board. Make sure both ends are securely plugged in; check the drive type in the standard CMOS setup. Backing up the hard drive is extremely important. All hard disks are capable of breaking down at any time.
System only boots from optical drive. Hard disk can be read and applications can be used but booting from hard disk is impossible.	<ol style="list-style-type: none"> Back up data and applications files. Reformat the hard drive. Re-install applications and data using backup disks.
Screen message says "Invalid Configuration" or "CMOS Failure."	Review system's equipment. Make sure correct information is in setup.
Cannot boot system after installing second hard drive.	<ol style="list-style-type: none"> Set master/slave jumpers correctly. Run SETUP program and select correct drive types. Call the drive manufacturers for compatibility with other drives.

APPENDENCIES: SPEC IN OTHER LANGUAGE

GERMAN

	<i>Ver 1.x / Ver 5.x</i>	<i>Ver 6.x</i>
CPU	Sockel AM2 AMD Athlon 64 / Athlon 64 FX / Athlon 64 x2 / Sempron Prozessoren Die AMD 64-Architektur unterstützt eine 32-Bit- und 64-Bit-Datenverarbeitung Unterstützt Hyper Transport und Cool'nQuiet	Sockel AM2 AMD Athlon 64 / Athlon 64 FX / Athlon 64 x2 / Sempron Prozessoren Die AMD 64-Architektur unterstützt eine 32-Bit- und 64-Bit-Datenverarbeitung Unterstützt Hyper Transport und Cool'nQuiet
FSB	Unterstützt HyperTransport mit einer Bandbreite von bis zu 1 GHz	Unterstützt HyperTransport mit einer Bandbreite von bis zu 1 GHz
Chipsatz	nForce 570 Ultra	nForce 570 Ultra
Super E/A	ITE 8716F Bietet die häufig verwendeten alten Super E/A-Funktionen. Low Pin Count-Schnittstelle Umgebungskontrolle, Hardware-Überwachung Lüfterdrehzahl-Controller "Smart Guardian"-Funktion von ITE	ITE 8716F Bietet die häufig verwendeten alten Super E/A-Funktionen. Low Pin Count-Schnittstelle Umgebungskontrolle, Hardware-Überwachung Lüfterdrehzahl-Controller "Smart Guardian"-Funktion von ITE
Arbeitsspeicher	DDR2 DIMM-Steckplätze x 4 Jeder DIMM unterstützt 256/512MB & 1GB DDR2. Max. 4GB Arbeitsspeicher Dual-Kanal DDR2 Speichermodul Unterstützt DDR2 533 / 667 / 800 registrierte DIMMs. ECC DIMMs werden nicht unterstützt.	DDR2 DIMM-Steckplätze x 4 Jeder DIMM unterstützt 256/512MB & 1GB DDR2. Max. 4GB Arbeitsspeicher Dual-Kanal DDR2 Speichermodul Unterstützt DDR2 533 / 667 / 800 registrierte DIMMs. ECC DIMMs werden nicht unterstützt.
IDE	Integrierter IDE-Controller Ultra DMA 33 / 66 / 100 / 133 Bus Master-Modus Unterstützt PIO-Modus 0~4,	Integrierter IDE-Controller Ultra DMA 33 / 66 / 100 / 133 Bus Master-Modus Unterstützt PIO-Modus 0~4,
SATA II	Integrierter Serial ATA-Controller Datenübertragungsraten bis zu 3Gb/s Konform mit der SATA-Spezifikation Version 2.0	Integrierter Serial ATA-Controller Datenübertragungsraten bis zu 3Gb/s Konform mit der SATA-Spezifikation Version 2.0
LAN	Marvell 88E1116 PHY 10 / 100 Mb/s und 1Gb/s Auto-Negotiation	Marvell 88E1116 PHY 10 / 100 Mb/s und 1Gb/s Auto-Negotiation

TForce 570 U

	Ver 1.x / Ver 5.x	Ver 6.x
Audio-Codec	Realtek ALC888 7.1-Kanal-Audioausgabe Unterstützt High-DefinitionAudio	Realtek ALC861VD 5.1-Kanal-Audioausgabe Unterstützt High-DefinitionAudio
Steckplätze	PCI-Steckplatz x3 PCI Express x16 Steckplatz x1 PCI Express x 1-Steckplatz x3	PCI-Steckplatz x3 PCI Express x16 Steckplatz x1 PCI Express x 1-Steckplatz x3
Onboard-Anschluss	Diskettenlaufwerkanschluss x1 Druckeranschluss Anschluss x1 IDE-Anschluss x1 SATA-Anschluss x6 Fronttafelanschluss x1 Front-Audioanschluss x1 CD-IN-Anschluss x1 S/PDIF- Ausgangsanschluss x1 CPU-Lüfter-Sockel x1 System-Lüfter-Sockel x3 "Gehäuse offen"-Sockel(optional) x1 "CMOS löschen"-Sockel x1 USB-Anschluss x2 Stromanschluss (24-polig) x1 Stromanschluss (8-polig) x1	Diskettenlaufwerkanschluss x1 Druckeranschluss Anschluss x1 IDE-Anschluss x1 SATA-Anschluss x6 Fronttafelanschluss x1 Front-Audioanschluss x1 CD-IN-Anschluss x1 S/PDIF- Ausgangsanschluss x1 CPU-Lüfter-Sockel x1 System-Lüfter-Sockel x3 "Gehäuse offen"-Sockel(optional) x1 "CMOS löschen"-Sockel x1 USB-Anschluss x2 Stromanschluss (24-polig) x1 Stromanschluss (8-polig) x1
Rückseiten-E/A	PS/2-Tastatur x1 PS/2-Maus x1 Serieller Anschluss x1 LAN-Anschluss x1 USB-Anschluss x6 Audioanschluss x6	PS/2-Tastatur x1 PS/2-Maus x1 Serieller Anschluss x1 LAN-Anschluss x1 USB-Anschluss x6 Audioanschluss x3
Platinengröße	244 mm (B) X 305 mm (L)	244 mm (B) X 305 mm (L)
Sonderfunktionen	NVIDIA nTunes Unterstützt RAID 0 / 1/ 0+1 / 5	NVIDIA nTunes Unterstützt RAID 0 / 1/ 0+1 / 5
OS-Unterstützung	Windows 2000 / XP / VISTA Biostar behält sich das Recht vor, ohne Ankündigung die Unterstützung für ein Betriebssystem hinzuzufügen oder zu entfernen.	Windows 2000 / XP / VISTA Biostar behält sich das Recht vor, ohne Ankündigung die Unterstützung für ein Betriebssystem hinzuzufügen oder zu entfernen.

FRANCE

	Ver 1.x / Ver 5.x	Ver 6.x
UC	Socket AM2 Processeurs AMD Athlon 64 / Athlon 64 FX / Athlon 64 x2/Sempron L'architecture AMD 64 permet le calcul 32 et 64 bits Prend en charge Hyper Transport et Cod'nQuiet	Socket AM2 Processeurs AMD Athlon 64 / Athlon 64 FX / Athlon 64 x2/Sempron L'architecture AMD 64 permet le calcul 32 et 64 bits Prend en charge Hyper Transport et Cod'nQuiet
Bus frontal	Prend en charge Hyper Transport jusqu'à une bande passante de 1 GHz	Prend en charge Hyper Transport jusqu'à une bande passante de 1 GHz
Chipset	nForce 570 Ultra	nForce 570 Ultra
Super E/S	ITE 8716F Fournit la fonctionnalité de Super E/S patrimoniales la plus utilisée. Interface à faible compte de broches Initiatives de contrôle environnementales, Moniteur de matériel Contrôleur de vitesse de ventilateur Fonction "Garden intelligent" de l'ITE	ITE 8716F Fournit la fonctionnalité de Super E/S patrimoniales la plus utilisée. Interface à faible compte de broches Initiatives de contrôle environnementales, Moniteur de matériel Contrôleur de vitesse de ventilateur Fonction "Garden intelligent" de l'ITE
Mémoire principale	Fentes DDR2 DIMM x 4 Chaque DIMM prend en charge des DDR2 de 256/512 Mo et 1 Go Capacité mémoire maximale de 4 Go Module de mémoire DDR2 à mode à double voie Prend en charge la DDR2 533 / 667 / 800 Les DIMM à registres et DIMM avec code correcteurs d'erreurs ne sont pas prises en charge	Fentes DDR2 DIMM x 4 Chaque DIMM prend en charge des DDR2 de 256/512 Mo et 1 Go Capacité mémoire maximale de 4 Go Module de mémoire DDR2 à mode à double voie Prend en charge la DDR2 533 / 667 / 800 Les DIMM à registres et DIMM avec code correcteurs d'erreurs ne sont pas prises en charge
IDE	Contrôleur IDE intégré Mode principale de Bus Ultra DMA 33 / 66 / 100 / 133 Prend en charge le mode PIO 0~4,	Contrôleur IDE intégré Mode principale de Bus Ultra DMA 33 / 66 / 100 / 133 Prend en charge le mode PIO 0~4,
SATA SATA II	Contrôleur Serial ATA intégré : Taux de transfert jusqu'à 3 Go/s. Conforme à la spécification SATA Version 2.0	Contrôleur Serial ATA intégré : Taux de transfert jusqu'à 3 Go/s. Conforme à la spécification SATA Version 2.0
LAN	Marvell 88E1116 PHY 10 / 100 Mb/s et 1 Gb/s négociation automatique	Marvell 88E1116 PHY 10 / 100 Mb/s et 1 Gb/s négociation automatique

TForce 570 U

	Ver 1.x / Ver 5.x	Ver 6.x
Codec audio	Realtek ALC888 Sortie audio à 7.1 voies Prise en charge de l'audio haute définition	Realtek ALC861VD Sortie audio à 5.1 voies Prise en charge de l'audio haute définition
Fentes	Fente PCI x3 Slot PCI Express x16 x1 Slot PCI Express x 1 x3	Fente PCI x3 Slot PCI Express x16 x1 Slot PCI Express x 1 x3
Connecteur embarqué	Connecteur de disquette x1 Connecteur de Port d'imprimante x1 Connecteur IDE x1 Connecteur SATA x6 Connecteur du panneau avant x1 Connecteur Audio du panneau avant x1 Connecteur d'entrée CD x1 Connecteur de sortie S/PDIF x1 Embase de ventilateur UC x1 Embase de ventilateur système x3 Embase d'ouverture de châssis (en option) x1 Embase d'effacement CMOS x1 Connecteur USB x2 Connecteur d'alimentation (24 broches) x1 Connecteur d'alimentation (8 broches) x1	Connecteur de disquette x1 Connecteur de Port d'imprimante x1 Connecteur IDE x1 Connecteur SATA x6 Connecteur du panneau avant x1 Connecteur Audio du panneau avant x1 Connecteur d'entrée CD x1 Connecteur de sortie S/PDIF x1 Embase de ventilateur UC x1 Embase de ventilateur système x3 Embase d'ouverture de châssis (en option) x1 Embase d'effacement CMOS x1 Connecteur USB x2 Connecteur d'alimentation (24 broches) x1 Connecteur d'alimentation (8 broches) x1
E/S du panneau arrière	Clavier PS/2 x1 Souris PS/2 x1 Port série x1 Port LAN x1 Port USB x6 Fiche audio x6	Clavier PS/2 x1 Souris PS/2 x1 Port série x1 Port LAN x1 Port USB x6 Fiche audio x3
Dimensions de la carte	244 mm (l) X 305 mm (H)	244 mm (l) X 305 mm (H)
Fonctionnalités spéciales	NVIDIA nTunes Prise en charge RAID 0 / 1 / 0+1 / 5	NVIDIA nTunes Prise en charge RAID 0 / 1 / 0+1 / 5
Support SE	Windows 2000 / XP / VISTA Biostar se réserve le droit d'ajouter ou de supprimer le support de SE avec ou sans préavis.	Windows 2000 / XP / VISTA Biostar se réserve le droit d'ajouter ou de supprimer le support de SE avec ou sans préavis.

ITALIAN

	Ver 1.x / Ver 5.x	Ver 6.x
CPU	Socket AM2 Processori AMD Athlon 64 / Athlon 64 FX / Athlon 64 x2/ Sempron L'architettura AMD 64 abilita la computazione 32 e 64 bit Supporto di Hyper Transport e Cool'n'Quiet	Socket AM2 Processori AMD Athlon 64 / Athlon 64 FX / Athlon 64 x2/ Sempron L'architettura AMD 64 abilita la computazione 32 e 64 bit Supporto di Hyper Transport e Cool'n'Quiet
FSB	Supporto di HyperTransport fino a 1 GHz di larghezza di banda	Supporto di HyperTransport fino a 1 GHz di larghezza di banda
Chipset	nForce 570 Ultra	nForce 570 Ultra
Super I/O	ITE 8716F Fornisce le funzionalità legacy Super I/O usate più comunemente. Interfaccia LPC (Low Pin Count) Funzioni di controllo dell'ambiente: Monitoraggio hardware Controller velocità ventolina Funzione "Smart Guardian" di ITE	ITE 8716F Fornisce le funzionalità legacy Super I/O usate più comunemente. Interfaccia LPC (Low Pin Count) Funzioni di controllo dell'ambiente: Monitoraggio hardware Controller velocità ventolina Funzione "Smart Guardian" di ITE
Memoria principale	Alloggi DIMM DDR 2 x 4 Ciascun DIMM supporta DDR2 256/512MB e 1GB Capacità massima della memoria a 4GB Modulo di memoria DDR2 a canale doppio Supporto di DDR2 533 / 667 / 800 DIMM registrati e DIMM ECC non sono supportati	Alloggi DIMM DDR 2 x 4 Ciascun DIMM supporta DDR2 256/512MB e 1GB Capacità massima della memoria a 4GB Modulo di memoria DDR2 a canale doppio Supporto di DDR2 533 / 667 / 800 DIMM registrati e DIMM ECC non sono supportati
IDE	Controller IDE integrato Modalità Bus Master Ultra DMA 33 / 66 / 100 / 133 Supporto modalità PIO Mode 0-4	Controller IDE integrato Modalità Bus Master Ultra DMA 33 / 66 / 100 / 133 Supporto modalità PIO Mode 0-4
SATA II	Controller Serial ATA integrato Velocità di trasferimento dei dati fino a 3 Gb/s. Compatibile specifiche SATA Versione 2.0.	Controller Serial ATA integrato Velocità di trasferimento dei dati fino a 3 Gb/s. Compatibile specifiche SATA Versione 2.0.
LAN	Marvell 88E1116 PHY Negoziazione automatica 10 / 100Mb/s e 1Gb/s	Marvell 88E1116 PHY Negoziazione automatica 10 / 100Mb/s e 1Gb/s

TForce 570 U

	Ver 1.x / Ver 5.x	Ver 6.x
Codec audio	Realtek ALC888 Uscita audio 7.1 canali Supporto audio High-Definition (HD)	Realtek ALC861VD Uscita audio 5.1 canali Supporto audio High-Definition (HD)
Alloggi	Alloggio PCI x3 Alloggio PCI Express x16 x1 Alloggio PCI Express x1 x3	Alloggio PCI x3 Alloggio PCI Express x16 x1 Alloggio PCI Express x1 x3
Connettori su scheda	Connettore floppy x1 Connettore Porta stampante x1 Connettore IDE x1 Connettore SATA x6 Connettore pannello frontale x1 Connettore audio frontale x1 Connettore CD-in x1 Connettore output SPDIF x1 Collettore ventolina CPU x1 Collettore ventolina sistema x3 Collettore apertura telaio (optional) x1 Collettore cancellazione CMOS x1 Connettore USB x2 Connettore alimentazione (24 pin) x1 Connettore alimentazione (8 pin) x1	Connettore floppy x1 Connettore Porta stampante x1 Connettore IDE x1 Connettore SATA x6 Connettore pannello frontale x1 Connettore audio frontale x1 Connettore CD-in x1 Connettore output SPDIF x1 Collettore ventolina CPU x1 Collettore ventolina sistema x3 Collettore apertura telaio (optional) x1 Collettore cancellazione CMOS x1 Connettore USB x2 Connettore alimentazione (24 pin) x1 Connettore alimentazione (8 pin) x1
I/O pannello posteriore	Tastiera PS/2 x1 Mouse PS/2 x1 Porta seriale x1 Porta LAN x1 Porta USB x6 Connettore audio x6	Tastiera PS/2 x1 Mouse PS/2 x1 Porta seriale x1 Porta LAN x1 Porta USB x6 Connettore audio x3
Dimensioni scheda	244 mm (larghezza) x 305 mm (altezza)	244 mm (larghezza) x 305 mm (altezza)
Caratteristiche speciali	nTunes NVIDIA Supporto RAID 0 / 1 / 0+1 / 5	nTunes NVIDIA Supporto RAID 0 / 1 / 0+1 / 5
Sistemi operativi supportati	Windows 2000 / XP / VISTA Biostar si riserva il diritto di aggiungere o rimuovere il supporto di qualsiasi sistema operativo senza preavviso.	Windows 2000 / XP / VISTA Biostar si riserva il diritto di aggiungere o rimuovere il supporto di qualsiasi sistema operativo senza preavviso.

SPANISH

	Ver 1.x / Ver 5.x	Ver 6.x
CPU	<p>Conector AM2</p> <p>Procesadores AMD Athlon 64 / Athlon 64 FX / Athlon 64 x2/ Sempron</p> <p>La arquitectura AMD 64 permite el procesamiento de 32 y 64 bits</p> <p>Soporta las tecnologías Hyper Transport y Cool'nQuiet</p>	<p>Conector AM2</p> <p>Procesadores AMD Athlon 64 / Athlon 64 FX / Athlon 64 x2/ Sempron</p> <p>La arquitectura AMD 64 permite el procesamiento de 32 y 64 bits</p> <p>Soporta las tecnologías Hyper Transport y Cool'nQuiet</p>
FSB	Admite HyperTransport con un ancho de banda de hasta 1 GHz	Admite HyperTransport con un ancho de banda de hasta 1 GHz
Conjunto de chips	nForce 570 Ultra	nForce 570 Ultra
Súper E/S	<p>ITE 8716F</p> <p>Le ofrece las funcionalidades heredadas de uso más común Súper E/S.</p> <p>Interfaz de cuenta Low Pin</p> <p>Iniciativas de control de entorno, Monitor hardware</p> <p>Controlador de velocidad de ventilador</p> <p>Función "Guarda inteligente" de ITE</p>	<p>ITE 8716F</p> <p>Le ofrece las funcionalidades heredadas de uso más común Súper E/S.</p> <p>Interfaz de cuenta Low Pin</p> <p>Iniciativas de control de entorno, Monitor hardware</p> <p>Controlador de velocidad de ventilador</p> <p>Función "Guarda inteligente" de ITE</p>
Memoria principal	<p>Ranuras DIMM DDR2 x 4</p> <p>Cada DIMM admite DDR de 256/512MB y 1GB</p> <p>Capacidad máxima de memoria de 4GB</p> <p>Módulo de memoria DDR2 de canal Doble</p> <p>Admite DDR2 de 533 / 667 / 800</p> <p>No admite DIMM registrados o DIMM compatibles con ECC</p>	<p>Ranuras DIMM DDR2 x 4</p> <p>Cada DIMM admite DDR de 256/512MB y 1GB</p> <p>Capacidad máxima de memoria de 4GB</p> <p>Módulo de memoria DDR2 de canal Doble</p> <p>Admite DDR2 de 533 / 667 / 800</p> <p>No admite DIMM registrados o DIMM compatibles con ECC</p>
IDE	<p>Controlador IDE integrado</p> <p>Modo bus maestro Ultra DMA 33/ 66 / 100/ 133</p> <p>Soporte los Modos PIO 0~4,</p>	<p>Controlador IDE integrado</p> <p>Modo bus maestro Ultra DMA 33/ 66 / 100/ 133</p> <p>Soporte los Modos PIO 0~4,</p>
SATA II	<p>Controlador ATA Serie Integrado</p> <p>Tasas de transferencia de hasta 3 Gb/s.</p> <p>Compatible con la versión SATA 2.0.</p>	<p>Controlador ATA Serie Integrado</p> <p>Tasas de transferencia de hasta 3 Gb/s.</p> <p>Compatible con la versión SATA 2.0.</p>
Red Local	<p>Marvell 88E1116 PHY</p> <p>Negociación de 10 / 100 Mb/s y 1 Gb/s</p>	<p>Marvell 88E1116 PHY</p> <p>Negociación de 10 / 100 Mb/s y 1 Gb/s</p>

TForce 570 U

	Ver 1.x / Ver 5.x	Ver 6.x
Códecs de sonido	Realtek ALC888 Salida de sonido de 7.1 canales Soporte de sonido de Alta Definición	Realtek ALC861VD Salida de sonido de 5.1 canales Soporte de sonido de Alta Definición
Ranuras	Ranura PCI X3 Ranura PCI Express x16 X1 Ranura PCI express x 1 X3	Ranura PCI X3 Ranura PCI Express x16 X1 Ranura PCI express x 1 X3
Conectores en placa	Conector disco flexible X1 Conector Puerto de impresora X1 Conector IDE X1 Conector SATA X6 Conector de panel frontal X1 Conector de sonido frontal X1 Conector de entrada de CD X1 Conector de salida S/PDIF X1 Cabecera de ventilador de CPU X1 Cabecera de ventilador de sistema X3 Cabecera de chasis abierto(opcional)X1 Cabecera de borrado de CMOS X1 Conector USB X2 Conector de alimentación X1 (24 patillas) Conector de alimentación X1 (8 patillas)	Conector disco flexible X1 Conector Puerto de impresora X1 Conector IDE X1 Conector SATA X6 Conector de panel frontal X1 Conector de sonido frontal X1 Conector de entrada de CD X1 Conector de salida S/PDIF X1 Cabecera de ventilador de CPU X1 Cabecera de ventilador de sistema X3 Cabecera de chasis abierto(opcional)X1 Cabecera de borrado de CMOS X1 Conector USB X2 Conector de alimentación X1 (24 patillas) Conector de alimentación X1 (8 patillas)
Panel trasero de E/S	Teclado PS/2 X1 Ratón PS/2 X1 Puerto serie X1 Puerto de red local X1 Puerto USB X6 Conector de sonido X6	Teclado PS/2 X1 Ratón PS/2 X1 Puerto serie X1 Puerto de red local X1 Puerto USB X6 Conector de sonido X3
Tamaño de la placa	244 mm. (A) X 305 Mm. (H)	244 mm. (A) X 305 Mm. (H)
Funciones especiales	NVIDIA nTunes Admite RAID 0 / 1 / 0+1 / 5	NVIDIA nTunes Admite RAID 0 / 1 / 0+1 / 5
Soporte de sistema operativo	Windows 2000 / XP / VISTA Bióstar se reserva el derecho de añadir o retirar el soporte de cualquier SO con o sin aviso previo.	Windows 2000 / XP / VISTA Bióstar se reserva el derecho de añadir o retirar el soporte de cualquier SO con o sin aviso previo.

PORTUGUESE

	Ver 1.x / Ver 5.x	Ver 6.x
CPU	<p>Socket AM2</p> <p>Processadores AMD Athlon 64 / Athlon 64 FX / Athlon 64 x2 / Sempron</p> <p>A arquitectura AMD 64 permite uma computação de 32 e 64 bits</p> <p>Suporta as tecnologias Hyper Transport e Cool'nQuiet</p>	<p>Socket AM2</p> <p>Processadores AMD Athlon 64 / Athlon 64 FX / Athlon 64 x2 / Sempron</p> <p>A arquitectura AMD 64 permite uma computação de 32 e 64 bits</p> <p>Suporta as tecnologias Hyper Transport e Cool'nQuiet</p>
FSB	Suporta a tecnologia HyperTransport com uma largura de banda até 1 GHz	Suporta a tecnologia HyperTransport com uma largura de banda até 1 GHz
Chipset	nForce 570 Ultra	nForce 570 Ultra
Especificação do Super I/O	<p>ITE 8716F</p> <p>Proporciona as funcionalidades mais utilizadas em termos da especificação Super I/O.</p> <p>Interface LPC (Low Pin Count).</p> <p>Iniciativas para controlo do ambiente</p> <p>Monitorização do hardware</p> <p>Controlador da velocidade da ventoinha</p> <p>Função "Smart Guardian" da ITE</p>	<p>ITE 8716F</p> <p>Proporciona as funcionalidades mais utilizadas em termos da especificação Super I/O.</p> <p>Interface LPC (Low Pin Count).</p> <p>Iniciativas para controlo do ambiente</p> <p>Monitorização do hardware</p> <p>Controlador da velocidade da ventoinha</p> <p>Função "Smart Guardian" da ITE</p>
Memória principal	<p>Ranuras DIMM DDR2 x 4</p> <p>Cada módulo DIMM suporta uma memória DDR2 de 256/512 MB & 1 GB</p> <p>Capacidade máxima de memória: 4 GB</p> <p>Módulo de memória DDR2 de canal duplo</p> <p>Suporta módulos DDR2 533 / 667 / 800</p> <p>Os módulos DIMM registados e os DIMM ECC não são suportados</p>	<p>Ranuras DIMM DDR2 x 4</p> <p>Cada módulo DIMM suporta uma memória DDR2 de 256/512 MB & 1 GB</p> <p>Capacidade máxima de memória: 4 GB</p> <p>Módulo de memória DDR2 de canal duplo</p> <p>Suporta módulos DDR2 533 / 667 / 800</p> <p>Os módulos DIMM registados e os DIMM ECC não são suportados</p>
IDE	<p>Controlador IDE integrado</p> <p>Modo Bus master Ultra DMA 33 / 66 / 100 / 133</p> <p>Suporta o modo PIO 0~4,</p>	<p>Controlador IDE integrado</p> <p>Modo Bus master Ultra DMA 33 / 66 / 100 / 133</p> <p>Suporta o modo PIO 0~4,</p>
SATA II	<p>Controlador Serial ATA integrado</p> <p>Velocidades de transmissão de dados até 3 Gb/s.</p> <p>Compatibilidade com a especificação SATA versão 2.0.</p>	<p>Controlador Serial ATA integrado</p> <p>Velocidades de transmissão de dados até 3 Gb/s.</p> <p>Compatibilidade com a especificação SATA versão 2.0.</p>
LAN	<p>Marvell 88E1116 PHY</p> <p>Auto negociação de 10 / 100 Mb/s e 1Gb/s</p>	<p>Marvell 88E1116 PHY</p> <p>Auto negociação de 10 / 100 Mb/s e 1Gb/s</p>

TForce 570 U

	Ver 1.x / Ver 5.x	Ver 6.x
Codec de som	Realtek ALC 888 Saída de áudio de 7.1 canais Suporta a especificação High-Definition Audio	Realtek ALC 861VD Saída de áudio de 5.1 canais Suporta a especificação High-Definition Audio
Ranhuras	Ranhura PCI x3 Ranhura PCI Express x16 x1 Ranhura PCI Express x 1 x3	Ranhura PCI x3 Ranhura PCI Express x16 x1 Ranhura PCI Express x 1 x3
Conectores na placa	Conector da unidade de disquetes x1 Conector da para impressora x1 Conector IDE x1 Conector SATA x6 Conector do painel frontal x1 Conector de áudio frontal x1 Conector para entrada de CDs x1 Conector de saída S/PDIF x1 Conector da verticinha da CPU x1 Conector da verticinha do sistema x3 Conector para detecção da abertura do chassis (opcional) x1 Conector para limpeza do CMOS x1 Conector USB x2 Conector de alimentação (24 pinos) x1 Conector de alimentação (8 pinos) x1	Conector da unidade de disquetes x1 Conector da para impressora x1 Conector IDE x1 Conector SATA x6 Conector do painel frontal x1 Conector de áudio frontal x1 Conector para entrada de CDs x1 Conector de saída S/PDIF x1 Conector da verticinha da CPU x1 Conector da verticinha do sistema x3 Conector para detecção da abertura do chassis (opcional) x1 Conector para limpeza do CMOS x1 Conector USB x2 Conector de alimentação (24 pinos) x1 Conector de alimentação (8 pinos) x1
Entradas/Saídas no painel traseiro	Teclado PS/2 x1 Rato PS/2 x1 Porta série x1 Porta LAN x1 Porta USB x6 Tomada de áudio x6	Teclado PS/2 x1 Rato PS/2 x1 Porta série x1 Porta LAN x1 Porta USB x6 Tomada de áudio x3
Tamanho da placa	244 mm (L) X 305 mm (A)	244 mm (L) X 305 mm (A)
Características especiais	nTunes da NVIDIA Suporta as funções RAID 0 / 1 / 0+1 / 5	nTunes da NVIDIA Suporta as funções RAID 0 / 1 / 0+1 / 5
Sistemas operativos suportados	Windows 2000 / XP / VISTA A Biostar reserva-se o direito de adicionar ou remover suporte para qualquer sistema operativo com ou sem aviso prévio.	Windows 2000 / XP / VISTA A Biostar reserva-se o direito de adicionar ou remover suporte para qualquer sistema operativo com ou sem aviso prévio.

POLISH

	Ver 1.x / Ver 5.x	Ver 6.x
Procesor	Socket AM2 AMD Athlon 64 / Athlon 64 FX / Athlon 64 x2/ Sempron Procesory Architektura AMD 64 umożliwia przetwarzanie 32 i 64 bitowe Obsługa Hyper Transport oraz Cool'n'Quiet	Socket AM2 AMD Athlon 64 / Athlon 64 FX / Athlon 64 x2/ Sempron Procesory Architektura AMD 64 umożliwia przetwarzanie 32 i 64 bitowe Obsługa Hyper Transport oraz Cool'n'Quiet
FSB	Obsługa HyperTransport o szerokości pasma do 1 GHz	Obsługa HyperTransport o szerokości pasma do 1 GHz
Chipset	nForce 570 Ultra	nForce 570 Ultra
Pamięć główna	Gniazda DDR2 DIMM x 4 Każde gniazdo DIMM obsługuje moduły 256/512MB oraz 1GB DDR2 Maks. wielkość pamięci 4GB Moduł pamięci DDR2 z trybem podwójnego kanału Obsługa DDR2 533 / 667 / 800 Brak obsługi Registered DIMM oraz ECC DIMM	Gniazda DDR2 DIMM x 4 Każde gniazdo DIMM obsługuje moduły 256/512MB oraz 1GB DDR2 Maks. wielkość pamięci 4GB Moduł pamięci DDR2 z trybem podwójnego kanału Obsługa DDR2 533 / 667 / 800 Brak obsługi Registered DIMM oraz ECC DIMM
Super I/O	ITE 8716F Zapewnia najbardziej powszechne funkcje Super I/O. Interfejs Low Pin Count Funkcje kontroli warunków pracy, Monitor H/W Kontroler prędkości wentylatora Funkcja ITE "Smart Guardian"	ITE 8716F Zapewnia najbardziej powszechne funkcje Super I/O. Interfejs Low Pin Count Funkcje kontroli warunków pracy, Monitor H/W Kontroler prędkości wentylatora Funkcja ITE "Smart Guardian"
IDE	Zintegrowany kontroler IDE Ultra DMA 33 / 66 / 100 / 133 Tryb Bus Master obsługa PIO tryb 0~4,	Zintegrowany kontroler IDE Ultra DMA 33 / 66 / 100 / 133 Tryb Bus Master obsługa PIO tryb 0~4,
SATA II	Zintegrowany kontroler Serial ATA Transfer danych do 3 Gb/s. Zgodność ze specyfikacją SATA w wersji 2.0.	Zintegrowany kontroler Serial ATA Transfer danych do 3 Gb/s. Zgodność ze specyfikacją SATA w wersji 2.0.
LAN	Marvell 88E1116 PHY 10 / 100 Mb/s oraz 1Gb/s z automatyczną negocjacją szybkości	Marvell 88E1116 PHY 10 / 100 Mb/s oraz 1Gb/s z automatyczną negocjacją szybkości

TForce 570 U

	Ver 1.x / Ver 5.x	Ver 6.x
Kodek dźwiękowy	Realtek ALC 888 7.1 kanałowe wyjście audio Obsługa High-Definition Audio	Realtek ALC 861VD 5.1 kanałowe wyjście audio Obsługa High-Definition Audio
Gniazda	Gniazdo PCI x3 Gniazdo PCI Express x16 x1 Gniazdo PCI Express x 1 x3	Gniazdo PCI x3 Gniazdo PCI Express x16 x1 Gniazdo PCI Express x 1 x3
Złącza wbudowane	Złącze napędu dyskietek x1 Złącze Port drukarki x1 Złącze IDE x1 Złącze SATA x6 Złącze panela przedniego x1 Przednie złącze audio x1 Złącze wejścia CD x1 Złącze wyjścia S/PDIF x1 Złącze głośnikowe wentylatora procesora x1 Złącze głośnikowe wentylatora systemowego x3 Złącze głośnikowe otwarcia obudowy (opcja) x1 Złącze głośnikowe kasowania CMOS x1 Złącze USB x2 Złącze zasilania (24 pinowe) x1 Złącze zasilania (8 pinowe) x1	Złącze napędu dyskietek x1 Złącze Port drukarki x1 Złącze IDE x1 Złącze SATA x6 Złącze panela przedniego x1 Przednie złącze audio x1 Złącze wejścia CD x1 Złącze wyjścia S/PDIF x1 Złącze głośnikowe wentylatora procesora x1 Złącze głośnikowe wentylatora systemowego x3 Złącze głośnikowe otwarcia obudowy (opcja) x1 Złącze głośnikowe kasowania CMOS x1 Złącze USB x2 Złącze zasilania (24 pinowe) x1 Złącze zasilania (8 pinowe) x1
Back Panel I/O	Klawiatura PS/2 x1 Mysz PS/2 x1 Port szeregowy x1 Port LAN x1 Port USB x6 Gniazdo audio x6	Klawiatura PS/2 x1 Mysz PS/2 x1 Port szeregowy x1 Port LAN x1 Port USB x6 Gniazdo audio x3
Wymiary płyty	244 mm (S) X 305 mm (W)	244 mm (S) X 305 mm (W)
Funkcje specjalne	NVIDIA nTunes. Obsługa RAID 0 / 1 / 0+1 / 5	NVIDIA nTunes. Obsługa RAID 0 / 1 / 0+1 / 5
Obsługa systemu operacyjnego	Windows 2000 / XP / VISTA Biostar zastrzega sobie prawo dodawania lub odwoływania obsługi dowolnego systemu operacyjnego bez powiadomienia.	Windows 2000 / XP / VISTA Biostar zastrzega sobie prawo dodawania lub odwoływania obsługi dowolnego systemu operacyjnego bez powiadomienia.

RUSSIAN

	Ver 1x / Ver 5x	Ver 6x
CPU (центральный процессор)	Гнездо AM2 Процессоры AMD Athlon 64 / Athlon 64 FX / Athlon 64X2 Архитектура AMD 64 разрешать обработка данных на 32 и 64 бит Поддержка Hyper Transport и Cool'nQuiet	Гнездо AM2 Процессоры AMD Athlon 64 / Athlon 64 FX / Athlon 64X2 Архитектура AMD 64 разрешать обработка данных на 32 и 64 бит Поддержка Hyper Transport и Cool'nQuiet
FSB	Поддержка HyperTransport с пропускной способностью до 1ГГц	Поддержка HyperTransport с пропускной способностью до 1ГГц
Набор микросхем	nForce 570 Ultra	nForce 570 Ultra
Основная память	Слоты DDR2 DIMM x 4 Каждый модуль DIMM поддерживает 256/512МБ & 1ГБ DDR2 Максимальная ёмкость памяти 4 ГБ Модуль памяти с двужанальным режимом DDR2 Поддержка DDR2 533 / 667 / 800 Не поддерживает зарегистрированные модули DIMM and ECC DIMM	Слоты DDR2 DIMM x 4 Каждый модуль DIMM поддерживает 256/512МБ & 1ГБ DDR2 Максимальная ёмкость памяти 4 ГБ Модуль памяти с двужанальным режимом DDR2 Поддержка DDR2 533 / 667 / 800 Не поддерживает зарегистрированные модули DIMM and ECC DIMM
Super I/O	ITE 8716F Обеспечивает наиболее используемые действующие функциональные возможности Super I/O. Интерфейс с низким количеством выводов Инициативы по охране окружающей среды, Аппаратный монитор Регулятор скорости Функция ITE "Smart Guardian" (Интеллектуальная защита)	ITE 8716F Обеспечивает наиболее используемые действующие функциональные возможности Super I/O. Интерфейс с низким количеством выводов Инициативы по охране окружающей среды, Аппаратный монитор Регулятор скорости Функция ITE "Smart Guardian" (Интеллектуальная защита)
IDE	Встроенное устройство управления встроенными интерфейсами устройств Режим "хвояина" шины Ultra DMA 33 / 66 / 100 / 133 Поддержка режима PIO 0~4,	Встроенное устройство управления встроенными интерфейсами устройств Режим "хвояина" шины Ultra DMA 33 / 66 / 100 / 133 Поддержка режима PIO 0~4,
SATA II	Встроенное последовательное устройство управления АТА скорость передачи данных до 3 гигабит/с. Соответствие спецификации SATA версия 2.0.	Встроенное последовательное устройство управления АТА скорость передачи данных до 3 гигабит/с. Соответствие спецификации SATA версия 2.0.
Локальная сеть	Marvell 88E1116 PHY Автоматическое согласование 10 / 100 Мб/с и 1Гб/с	Marvell 88E1116 PHY Автоматическое согласование 10 / 100 Мб/с и 1Гб/с

TForce 570 U

	Ver 1.x / Ver 5.x	Ver 6.x
Звуковой кодек	Realtek ALC 888 Звуковая поддержка High-Definition 7.1канальный звуковой выход	Realtek ALC 861VD Звуковая поддержка High-Definition 5.1канальный звуковой выход
Слоты	Слот PCI x3 Слот PCI Express x16 x1 Слот PCI Express x 1 x3	Слот PCI x3 Слот PCI Express x16 x1 Слот PCI Express x 1 x3
Встроенный разъём	Разъём НГМД x1 Разъём Порт подключения принтера x1 Разъём IDE x1 Разъём SATA x6 Разъём на лицевой панели x1 Входной звуковой разъём x1 Разъём ввода для CD x1 Разъём вывода для S/PDIF x1 Контактирующее приспособление вентилятора центрального процессора x1 Контактирующее приспособление вентилятора системы x3 Шасси открытого контактирующего приспособления (дополнительно) x1 Открытое контактирующее приспособление CMOS x1 USB-разъём x2 Разъём питания (24 вывод) x1 Разъём питания (8 вывод) x1	Разъём НГМД x1 Разъём Порт подключения принтера x1 Разъём IDE x1 Разъём SATA x6 Разъём на лицевой панели x1 Входной звуковой разъём x1 Разъём ввода для CD x1 Разъём вывода для S/PDIF x1 Контактирующее приспособление вентилятора центрального процессора x1 Контактирующее приспособление вентилятора системы x3 Шасси открытого контактирующего приспособления (дополнительно) x1 Открытое контактирующее приспособление CMOS x1 USB-разъём x2 Разъём питания (24 вывод) x1 Разъём питания (8 вывод) x1
Задняя панель средств ввода-вывода	Клавиатура PS/2 x1 Мышь PS/2 x1 Последовательный порт x1 Порт LAN x1 USB-порт x6 Гнездо для подключения наушников x6	Клавиатура PS/2 x1 Мышь PS/2 x1 Последовательный порт x1 Порт LAN x1 USB-порт x6 Гнездо для подключения наушников x3
Размер панели	244 мм (Ш) X 305мм (В)	244 мм (Ш) X 305мм (В)
Специальные технические характеристики	NVIDIA nTunes Поддержка RAID 0/ 1 / 0+1 / 5	NVIDIA nTunes Поддержка RAID 0/ 1 / 0+1 / 5
Поддержка OS	Windows 2000 / XP / VISTA Biostar сохраняет за собой право добавлять или удалять средства обеспечения для OS с или без предварительного уведомления.	Windows 2000 / XP / VISTA Biostar сохраняет за собой право добавлять или удалять средства обеспечения для OS с или без предварительного уведомления.

ARABIC

Ver 6.x	Ver 1.x / Ver 5.x	
AM2 مقبس AMD Athlon 64 / Athlon 64FX / Athlon 64 x2/ Sempron إجراء العمليات لحاسوبية بسعة 32 و64 بت AMD 64 تمكين تقنية Hyper Transport و Cod'nQuiet تدعم تقنية	AM2 مقبس AMD Athlon 64 / Athlon 64FX / Athlon 64 x2/ Sempron إجراء العمليات لحاسوبية بسعة 32 و64 بت AMD 64 تمكين تقنية Hyper Transport و Cod'nQuiet تدعم تقنية	وحدة لمعالجة المركبة
تردد 1000 بتربط إلى HyperTransport تدعم تقنية	تردد 1000 بتربط إلى HyperTransport تدعم تقنية	النقل الأمامي لجلب
nForce 570 Ultra	nForce 570 Ultra	مجموعة لشراخ
عدد 4 فتحة DIMM DDR2 ميجا 256/512 سعة DDR2 دعم ذاكرة من نوع DIMM تدعم كل فتحة بليت و 1 جيجا بليت سعة ذاكرة قصوى 4 جيجا بايت مزوجة لفتحة DDR2 و وحدة ذاكرة ساعات 800 / 667 / 533 ميجا بايت DDR2 تدعم الذاكرة من نوع ECC و تلك التي لا تتوافق مع DIMM لا دعم رقائق الذاكرة	عدد 4 فتحة DIMM DDR2 ميجا 256/512 سعة DDR2 دعم ذاكرة من نوع DIMM تدعم كل فتحة بليت و 1 جيجا بليت سعة ذاكرة قصوى 4 جيجا بايت مزوجة لفتحة DDR2 و وحدة ذاكرة ساعات 800 / 667 / 533 ميجا بايت DDR2 تدعم الذاكرة من نوع ECC و تلك التي لا تتوافق مع DIMM لا دعم رقائق الذاكرة	الذاكرة الرئيسية
ITE 8716F الأكثر استخداماً، Super I/O توفر وظيفة Low Pin Count Interface تدعم تقنية وسائل التحكم في البيئة: مراقب لمعومة حلقة الأجهزة مراقب في سعة لمروحة ITE من "Smart Guardian" وظيفة	ITE 8716F الأكثر استخداماً، Super I/O توفر وظيفة Low Pin Count Interface تدعم تقنية وسائل التحكم في البيئة: مراقب لمعومة حلقة الأجهزة مراقب في سعة لمروحة ITE من "Smart Guardian" وظيفة	Super I/O
متكامل IDE متحكم Ultra DMA 33 / 66 / 100 / 133 نقل ببقية وضع رئيسي PIO Mode 0~4 دعم وضع	متكامل IDE متحكم Ultra DMA 33 / 66 / 100 / 133 نقل ببقية وضع رئيسي PIO Mode 0~4 دعم وضع	منفذ IDE
متكامل Serial ATA متحكم نقل البيانات بسرعات تصل إلى 3 جيجابت/ثانية. 2.0 الإصدار SATA مطابقة لمواصفات	متكامل Serial ATA متحكم نقل البيانات بسرعات تصل إلى 3 جيجابت/ثانية. 2.0 الإصدار SATA مطابقة لمواصفات	SATA II
Marvell 88E1116 PHY تقويض فئتي 100/10 ميجا بايت / ثلثية و 1 جيجا بت/ثانية	Marvell 88E1116 PHY تقويض فئتي 100/10 ميجا بايت / ثلثية و 1 جيجا بت/ثانية	شبكة داخلية
Realtek ALC861VD تدعم تقنية لصوت علي تعريف من 5.1 قنوات لخرج الصوت	Realtek ALC888 تدعم تقنية لصوت علي تعريف من 7.1 قنوات لخرج الصوت	كوديك الصوت

TForce 570 U

Ver 6.x		Ver 1.x / Ver 5.x		
عدد 3	فتحة PCI	عدد 3	فتحة PCI	التحت
عدد 1	فتحة PCI Express x16	عدد 1	فتحة PCI Express x16	
عدد 3	فتحة PCI Express x1	عدد 3	فتحة PCI Express x1	
عدد 1	مقذ محرك أقراص مرنة	عدد 1	مقذ محرك أقراص مرنة	الغلاف على سطح اللوحة
عدد 1	مقذ طابعة	عدد 1	مقذ طابعة	
عدد 1	مقذ IDE	عدد 1	مقذ IDE	
عدد 6	مقذ SATA	عدد 6	مقذ SATA	
عدد 1	مقذ اللوحة الأممية	عدد 1	مقذ اللوحة الأممية	
عدد 1	مقذ الصوت الأممي	عدد 1	مقذ الصوت الأممي	
عدد 1	مقذ CD-IN	عدد 1	مقذ CD-IN	
عدد 1	مقذ خرج S/PDIF	عدد 1	مقذ خرج S/PDIF	
عدد 1	وصلة مروحة وحدة المعالجة المركزية	عدد 1	وصلة مروحة وحدة المعالجة المركزية	
عدد 3	وصلة مروحة للظلم	عدد 3	وصلة مروحة للظلم	
عدد 1	وصلة فتح الهيكل (اختياري)	عدد 1	وصلة فتح الهيكل (اختياري)	
عدد 1	وصلة مسح CMOS	عدد 1	وصلة مسح CMOS	
عدد 2	مقذ USB	عدد 2	مقذ USB	
عدد 1	مقذ توصيل الطاقة (24دوس)	عدد 1	مقذ توصيل الطاقة (24دوس)	
عدد 1	مقذ توصيل الطاقة (8دبليس)	عدد 1	مقذ توصيل الطاقة (8دبليس)	
عدد 1	لوحة مفاتيح PS/2	عدد 1	لوحة مفاتيح PS/2	منافذ إدخال/خرج اللوحة الخلفية
عدد 1	مؤس PS/2	عدد 1	مؤس PS/2	
عدد 1	مقذ تسلسلي	عدد 1	مقذ تسلسلي	
عدد 1	مقذ شبكة لتصل محلية	عدد 1	مقذ شبكة لتصل محلية	
عدد 6	منافذ USB	عدد 6	منافذ USB	
عدد 3	مقيس صوت	عدد 6	مقيس صوت	
NVIDIA nTunes		NVIDIA nTunes		مزايا خاصة
RAID 0 / 1 / 0+1 / 5 تدعم تقنية		RAID 0 / 1 / 0+1 / 5 تدعم تقنية		
244مم (عرض) X 305مم (ارتفاع)		244مم (عرض) X 305مم (ارتفاع)		حجم اللوحة
Windows 2000 / XP / VISTA		Windows 2000 / XP / VISTA		دعم أنظمة تشغيل بيون إكسل. بخفا في إضفة أو إزالة الدعم لفي نظام تشغيل بإخطل أو Biostar تحتفظ بيون إكسل.
بيون إكسل.		بيون إكسل.		

JAPANESE

	Ver 1.x / Ver 5.x	Ver 6.x
CPU	Socket AM2 AMDAthlon 64 / Athlon 64 FX / Athlon 64 x2/ Sempron プロセッサ AMD64アーキテクチャでは、32ビットと64ビット計算が可能で ハイパートランスポートとクールアンドクワイアットをサポートします	Socket AM2 AMDAthlon 64 / Athlon 64 FX / Athlon 64 x2/ Sempron プロセッサ AMD64アーキテクチャでは、32ビットと64ビット計算が可能で ハイパートランスポートとクールアンドクワイアットをサポートします
FSB	1GHzのバンド幅までハイパートランスポートをサポートします	1GHzのバンド幅までハイパートランスポートをサポートします
チップセット	nForce 570 Ultra	nForce 570 Ultra
メインメモリ	DDR2 DIMMスロット x 4 各DIMMは 256/512MB & 1GB DDR2をサポート 最大メモリ容量4GB デュアルチャンネルモードDDR2メモリモジュール DDR2 533 / 667 / 800をサポート 登録済みDIMMとECC DIMMはサポートされません	DDR2 DIMMスロット x 4 各DIMMは 256/512MB & 1GB DDR2をサポート 最大メモリ容量4GB デュアルチャンネルモードDDR2メモリモジュール DDR2 533 / 667 / 800をサポート 登録済みDIMMとECC DIMMはサポートされません
Super I/O	ITE 8716F もっとも一般に使用されるレガシーSuper I/O機能を採用しています。 低ピンカウントインターフェイス 環境コントロールイニシアチブ、 H/Wモニター ファン速度コントローラ/ モニター ITEの「スマートガーディアン」機能	ITE 8716F もっとも一般に使用されるレガシーSuper I/O機能を採用しています。 低ピンカウントインターフェイス 環境コントロールイニシアチブ、 H/Wモニター ファン速度コントローラ/ モニター ITEの「スマートガーディアン」機能
IDE	統合IDEコントローラ Ultra DMA 33 / 66 / 100 / 133バスマスタモード PIO Mode 0~4のサポート、	統合IDEコントローラ Ultra DMA 33 / 66 / 100 / 133バスマスタモード PIO Mode 0~4のサポート、
SATA II	統合シリアルATAコントローラ 最高3 Gb/秒のデータ転送速度 SATAバージョン2.0仕様に準拠。	統合シリアルATAコントローラ 最高3 Gb/秒のデータ転送速度 SATAバージョン2.0仕様に準拠。
LAN	Marvell 88E1116 PHY 10 / 100 Mb/秒および1Gb/秒のオートネゴシエーション	Marvell 88E1116 PHY 10 / 100 Mb/秒および1Gb/秒のオートネゴシエーション

TForce 570 U

	Ver 1.x / Ver 5.x	Ver 6.x
サウンド Codec	Realtek ALC 888 ハイデフィニションオーディオのサポート 7.1 チャンネルオーディオアウト	Realtek ALC 861VD ハイデフィニションオーディオのサポート 5.1 チャンネルオーディオアウト
スロット	PCIスロット x3 PCI Express x16スロット x1 PCI Express x 1スロット x3	PCIスロット x3 PCI Express x16スロット x1 PCI Express x 1スロット x3
オンボードコ ネクタ	フロッピーコネクタ x1 プリンタポートコネクタ x1 IDEコネクタ x1 SATAコネクタ x6 フロントパネルコネクタ x1 フロントオーディオコネクタ x1 CDインコネクタ x1 S/PDIFアウトコネクタ x1 CPUファンヘッダ x1 システムファンヘッダ x3 シャーシオープンヘッダ(オプション) x1 CMOS クリアヘッダ x1 USBコネクタ x2 電源コネクタ(24ピン) x1 電源コネクタ(8ピン) x1	フロッピーコネクタ x1 プリンタポートコネクタ x1 IDEコネクタ x1 SATAコネクタ x6 フロントパネルコネクタ x1 フロントオーディオコネクタ x1 CDインコネクタ x1 S/PDIFアウトコネクタ x1 CPUファンヘッダ x1 システムファンヘッダ x3 シャーシオープンヘッダ(オプション) x1 CMOS クリアヘッダ x1 USBコネクタ x2 電源コネクタ(24ピン) x1 電源コネクタ(8ピン) x1
背面パネル I/O	PS/2キーボード x1 PS/2マウス x1 シリアルポート x1 LANポート x1 USBポート x6 オーディオジャック x6	PS/2キーボード x1 PS/2マウス x1 シリアルポート x1 LANポート x1 USBポート x6 オーディオジャック x3
ボードサイズ	244 mm (幅) X 305 mm (高さ)	244 mm (幅) X 305 mm (高さ)
特殊機能	NVIDIA nTunes RAID 0 / 1 / 0+1 / 5 のサポート	NVIDIA nTunes RAID 0 / 1 / 0+1 / 5 のサポート
OSサポート	Windows 2000 / XP / VISTA Biostarは事前のサポートなしにOSサポートを追加ま たは削除する権利を留保します。	Windows 2000 / XP / VISTA Biostarは事前のサポートなしにOSサポートを追加ま たは削除する権利を留保します。

2006/11/09

TForce 570 U

BIOS Setup	1
1 Main Menu	3
2 Standard CMOS Features.....	7
3 Advanced BIOS Features	9
4 Advanced Chipset Features.....	16
5 Integrated Peripherals.....	18
6 Power Management Setup.....	24
7 PnP/PCI Configurations.....	28
8 PC Health Status	31
9 OverClock Navigator Engine.....	34
10 CMOS Reload Program (C.R.P.).....	43

TForce 570 U

BIOS Setup

Introduction

The purpose of this manual is to describe the settings in the Award™ BIOS Setup program on this motherboard. The Setup program allows users to modify the basic system configuration and save these settings to CMOS RAM. The power of CMOS RAM is supplied by a battery so that it retains the Setup information when the power is turned off.

Basic Input-Output System (BIOS) determines what a computer can do without accessing programs from a disk. This system controls most of the input and output devices such as keyboard, mouse, serial ports and disk drives. BIOS activates at the first stage of the booting process, loading and executing the operating system. Some additional features, such as virus and password protection or chipset fine-tuning options are also included in BIOS.

The rest of this manual will to guide you through the options and settings in BIOS Setup.

Plug and Play Support

This AWARD BIOS supports the Plug and Play Version 1.0A specification and ESCD (Extended System Configuration Data) write.

EPA Green PC Support

This AWARD BIOS supports Version 1.03 of the EPA Green PC specification.

APM Support

This AWARD BIOS supports Version 1.1&1.2 of the Advanced Power Management (APM) specification. Power management features are implemented via the System Management Interrupt (SMI). Sleep and Suspend power management modes are supported. Power to the hard disk drives and video monitors can also be managed by this AWARD BIOS.

ACPI Support

Award ACPI BIOS support Version 1.0 of Advanced Configuration and Power interface specification (ACPI). It provides ASL code for power management and device configuration capabilities as defined in the ACPI specification, developed by Microsoft, Intel and Toshiba.

TForce 570 U

PCI Bus Support

This AWARD BIOS also supports Version 2.1 of the Intel PCI (Peripheral Component Interconnect) local bus specification.

DRAM Support

DDR SDRAM (Double Data Rate Synchronous DRAM) is supported.

Supported CPUs

This AWARD BIOS supports the AMD CPU.

Using Setup

Use the arrow keys to highlight items in most of the place, press <Enter> to select, use the <PgUp> and <PgDn> keys to change entries, press <F1> for help and press <Esc> to quit. The following table provides more detail about how to navigate in the Setup program by using the keyboard.

Keystroke	Function
Up arrow	Move to previous item
Down arrow	Move to next item
Left arrow	Move to the item on the left (menu bar)
Right arrow	Move to the item on the right (menu bar)
Move Enter	Move to the item you desired
PgUp key	Increase the numeric value or make changes
PgDn key	Decrease the numeric value or make changes
+ Key	Increase the numeric value or make changes
- Key	Decrease the numeric value or make changes
Esc key	Main Menu – Quit and not save changes into CMOS Status Page Setup Menu and Option Page Setup Menu – Exit Current page and return to Main Menu
F1 key	General help on Setup navigation keys
F5 key	Load previous values from CMOS
F7 key	Load the optimized defaults
F10 key	Save all the CMOS changes and exit

TForce 570 U

1 Main Menu

Once you enter Award BIOS™ CMOS Setup Utility, the Main Menu will appear on the screen. The Main Menu allows you to select from several setup functions. Use the arrow keys to select among the items and press <Enter> to accept and enter the sub-menu.

!! WARNING !!

For better system performance, the BIOS firmware is being continuously updated. The BIOS information described in this manual (**Figure 1, 2, 3, 4, 5, 6, 7, 8, 9**) is for your reference only. The actual BIOS information and settings on board may be slightly different from this manual.

■ **Figure 1: Main Menu**



Standard CMOS Features

This submenu contains industry standard configurable options.

Advanced BIOS Features

This submenu allows you to configure advanced features of the BIOS.

TForce 570 U

Advanced Chipset Features

This submenu allows you to configure special chipset features.

Integrated Peripherals

This submenu allows you to configure certain IDE hard drive options and Programmed Input/ Output features.

Power Management Setup

This submenu allows you to configure the power management features.

PnP/PCI Configurations

This submenu allows you to configure certain “Plug and Play” and PCI options.

PC Health Status

This submenu allows you to monitor the hardware of your system.

OverClock Navigator Engine

This submenu allows you to change CPU Vcore Voltage and CPU/PCI clock. (However, we suggest you to use the default setting. Changing the voltage and clock improperly may damage the CPU or M/B!)

CMOS Reload Program

The CMOS Reload Program (CRP) allows you to save different CMOS settings into BIOS-ROM.

Load Optimized Defaults

This selection allows you to reload the BIOS when problem occurs during system booting sequence. These configurations are factory settings optimized for this system. A confirmation message will be displayed before defaults are set.



Load Optimized Defaults (Y/N)? N

TForce 570 U

Set Supervisor Password

Setting the supervisor password will prohibit everyone except the supervisor from making changes using the CMOS Setup Utility. You will be prompted with to enter a password.



```
Enter Password:
```

Set User Password

If the Supervisor Password is not set, then the User Password will function in the same way as the Supervisor Password. If the Supervisor Password is set and the User Password is set, the “User” will only be able to view configurations but will not be able to change them.



```
Enter Password:
```

Save & Exit Setup

Save all configuration changes to CMOS (memory) and exit setup. Confirmation message will be displayed before proceeding.



```
SAVE to CMOS and EXIT (Y/N)? Y
```

Exit Without Saving

Abandon all changes made during the current session and exit setup. Confirmation message will be displayed before proceeding.



```
Quit Without Saving (Y/N)? N
```

TForce 570 U

Integrate Flashing Program

This is a very safe way to upgrade BIOS.

By pressing “Enter” key for three times, and the upgrading process will be completed easily.

A rectangular box with a double border containing the text "BIOS UPDATE UTILITY <Y/N>? Y".

BIOS UPDATE UTILITY <Y/N>? Y

TForce 570 U

2 Standard CMOS Features

The items in Standard CMOS Setup Menu are divided into several categories. Each category includes no, one or more than one setup items. Use the arrow keys to highlight the item and then use the <PgUp> or <PgDn> keys to select the value you want in each item.

■ **Figure 2: Standard CMOS Setup**

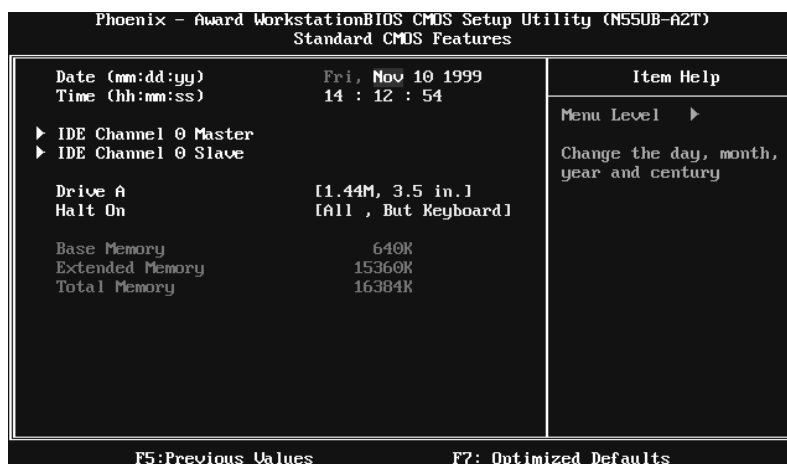

Main Menu Selections

This table shows the items and the available options on the Main Menu.

Item	Options	Description
Date	mm : dd : yy	Set the system date. Note that the 'Day' automatically changes when you set the date.
Time	hh : mm : ss	Set the system internal clock.
IDE Channel 0 Master	Options are in its sub menu.	Press <Enter> to enter the sub menu of detailed options
IDE Channel 0 Slave	Options are in its sub menu.	Press <Enter> to enter the sub menu of detailed options.
Drive A	360K, 5.25 in 1.2M, 5.25 in	Select the type of floppy disk drive installed in your

TForce 570 U

Item	Options	Description
	720K, 3.5 in 1.44M, 3.5 in 2.88M, 3.5 in None	system.
Halt On	All Errors No Errors All, but Keyboard All, but Diskette All, but Disk/ Key	Select the situation in which you want the BIOS to stop the POST process and notify you.
Base Memory	N/A	Displays the amount of conventional memory detected during boot up.
Extended Memory	N/A	Displays the amount of extended memory detected during boot up.
Total Memory	N/A	Displays the total memory available in the system.

TForce 570 U

3 Advanced BIOS Features

■ Figure 3: Advanced BIOS Setup

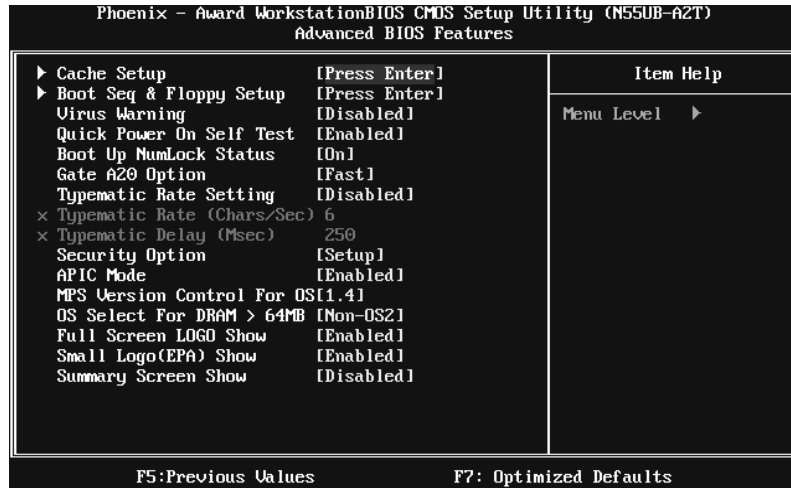

Cache Setup

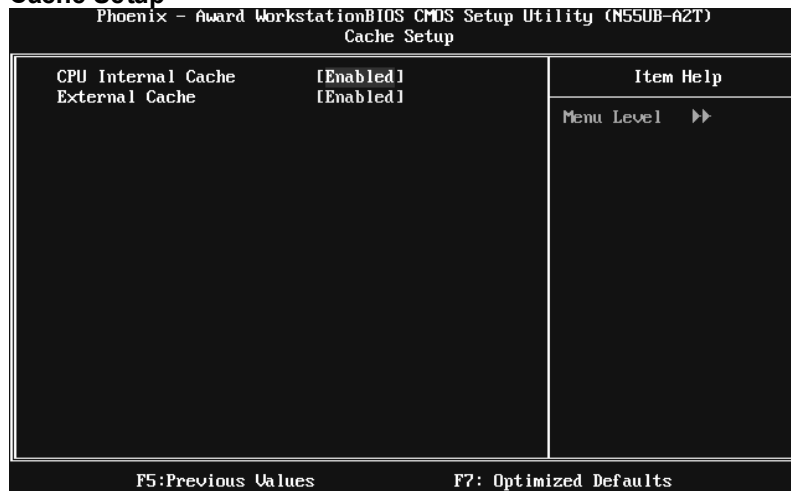

TForce 570 U

CPU Internal Cache

Depending on the CPU/chipset in use, you may be able to increase memory access time with this option.

Enabled (default) Enable cache.

Disabled Disable cache.

External Cache

This option enables or disables "Level 2" secondary cache on the CPU, which may improve performance.

Enabled (default) Enable cache.

Disabled Disable cache.

Boot Seq & Floppy Setup

This item allows you to setup boot sequence & Floppy.

Phoenix - Award Workstation BIOS CMOS Setup Utility (M55UB-A2T)	
Boot Seq & Floppy Setup	
▶ Removable Device Priority [Press Enter]	Item Help
▶ Hard Disk Boot Priority [Press Enter]	Menu Level ▶▶
▶ CD-ROM Boot Priority [Press Enter]	Select Network Boot
▶ Network Boot Priority [Press Enter]	Device Priority
First Boot Device [Removable]	
Second Boot Device [Hard Disk]	
Third Boot Device [CDROM]	
Boot Other Device [Enabled]	
Boot Up Floppy Seek [Enabled]	

F5: Previous Values F7: Optimized Defaults

TForce 570 U

Removable Device Priority

Select Removable Boot Device Priority.

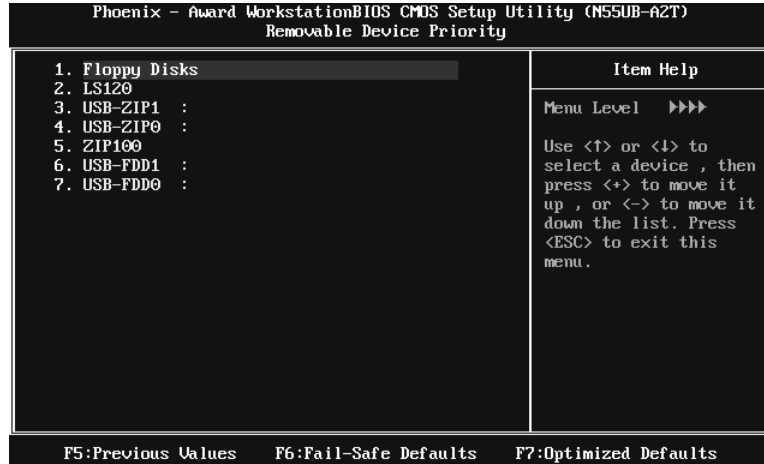

The Choices: Floppy Disks, Zip100, USB-FDD0, USB-FDD1, USB-ZIP0, USB-ZIP1, LS120.

Hard Disk Boot Priority

The BIOS will attempt to arrange the Hard Disk boot sequence automatically.

You can change the Hard Disk booting sequence here.



The Choices: Pri. Master, Pri. Slave, Sec. Master, Sec. Slave, USB HDD0, USB HDD1, USB HDD2, and Bootable Add-in Cards.

TForce 570 U

CD-ROM Boot Priority

Phoenix - Award WorkstationBIOS CMOS Setup Utility (N55UB-A2T)	
CD-ROM Boot Priority	
1. Pri.Slave : <input type="text"/>	Item Help
2. Pri.Master:	Menu Level >>>>
3. USB-CDROM0:	Use <↑> or <↓> to select a device , then press <+> to move it up , or <-> to move it down the list. Press <ESC> to exit this menu.
4. Sec.Master:	
5. Sec.Slave :	
6. USB-CDROM1:	
F5:Previous Values F6:Fail-Safe Defaults F7:Optimized Defaults	

The Choices: Pri. Master, Pri. Slave, Sec. Master, Sec. Slave, USB-CDROM0, USB-CDROM 1.

Network Boot Priority

Phoenix - Award WorkstationBIOS CMOS Setup Utility (N55UB-A2T)	
Network Boot Priority	
1. Network 0 : <input type="text"/>	Item Help
2. Network 1 :	Menu Level >>>>
3. Network 2 :	Use <↑> or <↓> to select a device , then press <+> to move it up , or <-> to move it down the list. Press <ESC> to exit this menu.
4. Network 3 :	
5.	
F5:Previous Values F6:Fail-Safe Defaults F7:Optimized Defaults	

The Choices: Network 0, Network 1, Network 2, Network 3.

TForce 570 U

First/Second/Third Boot Device

The BIOS will attempt to load the operating system in this order.

The Choices: Removable, Hard Disk, CDROM, Network, Disabled.

Boot Other Device

When enabled, BIOS will try to load the operating system from other device when it failed to load from the three devices above.

The Choices: Enabled (default), Disabled

Boot Up Floppy Seek

When enabled, System will test the floppy drives to determine if they have 40 or 80 tracks during boot up. Disabling this option reduces the time it takes to boot-up.

The Choices: Enabled (default), Disabled.

Virus Warning

This option allows you to choose the VIRUS Warning feature that is used to protect the IDE Hard Disk boot sector. If this function is enabled and an attempt is made to write to the boot sector, BIOS will display a warning message on the screen and sound an alarm beep.

Disabled (default) Virus protection is disabled.

Enabled Virus protection is activated.

Quick Power On Self Test

Enabling this option will cause an abridged version of the Power On Self-Test (POST) to execute after you power up the computer.

Disabled Normal POST.

Enabled (default) Enable quick POST.

TForce 570 U

Boot Up NumLock Status

Selects the NumLock State after the system switched on.

The Choices:

On (default) Numpad is number keys.
Off Numpad is arrow keys.

Gate A20 Option

Select if chipset or keyboard controller should control Gate A20.

Normal A pin in the keyboard controller controls GateA20.
Fast (default) Lets chipset control Gate A20.

Typematic Rate Setting

When a key is held down, the keystroke will repeat at a rate determined by the keyboard controller. When enabled, the typematic rate and typematic delay can be configured.

The Choices: **Disabled** (default), Enabled.

Typematic Rate (Chars/Sec)

Sets the rate at which a keystroke is repeated when you hold the key down.

The Choices: **6** (default), 8, 10, 12, 15, 20, 24, 30.

Typematic Delay (Msec)

Sets the delay time after the key is held down before it begins to repeat the keystroke.

The Choices: **250** (default), 500, 750, 1000.

Security Option

This option will enable only individuals with passwords to bring the system online and/or to use the CMOS Setup Utility.

System: A password is required for the system to boot and is also required to access the Setup Utility.

Setup (default): A password is required to access the Setup Utility only.
This will only apply if passwords are set from the Setup main menu.

TForce 570 U

APIC MODE

Selecting Enabled enables APIC device mode reporting from the BIOS to the operating system.

The Choices: Enabled (default), Disabled.

MPS Version Control For OS

The BIOS supports version 1.1 and 1.4 of the Intel multiprocessor specification. Select version supported by the operation system running on this computer.

The Choices: 1.4 (default), 1.1.

OS Select For DRAM > 64MB

A choice other than Non-OS2 is only used for OS2 systems with memory exceeding 64MB.

The Choices: Non-OS2 (default), OS2.

Full Screen LOGO Show

This item allows you to enable/disable Full Screen LOGO Show.

The Choices: Enabled (default), Disabled.

Small Logo(EPA) Show

This item allows you to select whether the “Small Logo” shows. Enabled (default) “Small Logo” shows when system boots up. Disabled No “Small Logo” shows when system boots.

The Choices: Enabled (default), Disabled.

Summary Screen Show

This item allows you to enable/disable the summary screen. Summary screen means system configuration and PCI device listing.

The Choices: Disabled (default), Enabled.

TForce 570 U

4 Advanced Chipset Features

This submenu allows you to configure the specific features of the chipset installed on your system. This chipset manage bus speeds and access to system memory resources, such as DRAM. It also coordinates communications with the PCI bus. The default settings that came with your system have been optimized and therefore should not be changed unless you are suspicious that the settings have been changed incorrectly.

■ **Figure 4: Advanced Chipset Setup**



PMU

This item allows you to enable or disable the PMU function.

The Choices: **Disabled** (default), Auto.

K8<->NB HT Width

This item allows you to select the K8<->NB HT Width.

The Choices: **Auto**(default), [↓ 8 ↑ 8], [↓ 16 ↑ 16].

SATA /PCIE Spread Spectrum

This item allows you to enable/disable the Spread Spectrum function.

The Choices: **Disabled** (default), Enabled.

TForce 570 U

HT Spread Spectrum

This item allows you to select HT Spread Spectrum function.

The Choices: Center(default), Down, Disabled.

SSE/SSE2 instruction

This item allows you to enable/disable SSE/SSE2 instruction.

The Choices: Enabled (default), Disabled.

CPU Feature

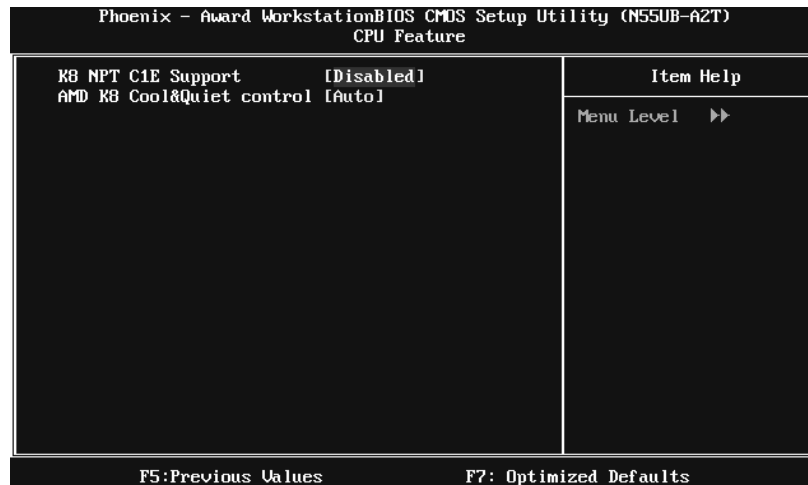

K8 NPT C1E Support

The Choices: Disabled (default), Enabled.

AMD K8 Cool&Quiet control

The Choices: Auto (default), Disabled.

System BIOS Cacheable

Selecting the “Enabled” option allows caching of the system BIOS ROM at F0000h-FFFFFFh, which is able to improve the system performance. However, any programs that attempts to write to this memory block will cause conflicts and result in system errors.

The Choices: Disabled (default), Enabled.

TForce 570 U

5 Integrated Peripherals

■ Figure 5. Integrated Peripherals

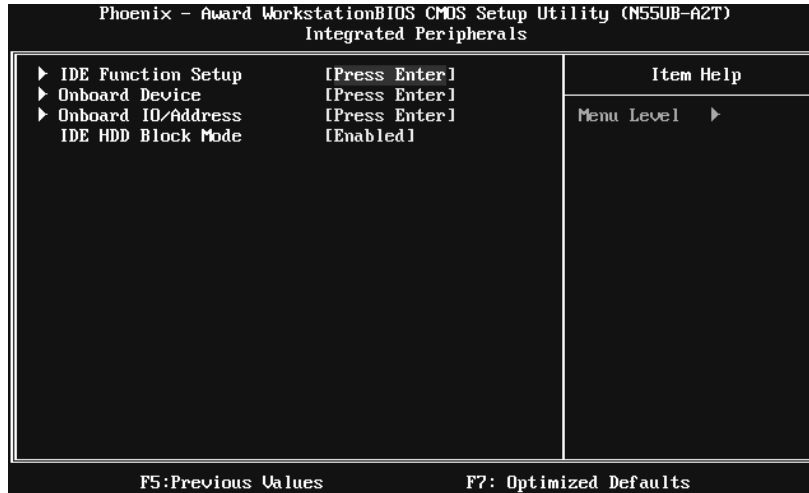

IDE Function Setup

Highlight the “Press Enter” label next to the “IDE Function Setup” label and press enter key will take you a submenu with the following options:



TForce 570 U

RAID Config

Phoenix - Award WorkstationBIOS CMOS Setup Utility (N55UB-A2T)
RAID Config

RAID Enable	[Disabled]	Item Help
× SATA 1 Primary	RAID Disabled	Menu Level >>>>
× SATA 1 Secondary	RAID Disabled	
× SATA 2 Primary	RAID Disabled	
× SATA 2 Secondary	RAID Disabled	
× SATA 3 Primary	RAID Disabled	
× SATA 3 Secondary	RAID Disabled	

F5: Previous Values F7: Optimized Defaults

RAID Enable

This option allows you to enable or disable RAID function.

The Choices: Disabled (default), Enabled.

SATA 1/2/3 Primary/Secondary RAID

This option allows you to enable or disable SATA A Primary/Secondary RAID.

The Choices: Disabled (default), Enabled.

On-chip IDE Channel 0

The motherboard chipset contains a PCI IDE interface with support for two IDE channels. Select "Enabled" to activate the first and/or second IDE interface. Select "Disabled" to deactivate an interface if you are going to install a primary and/or secondary add-in IDE interface.

The Choices: Enabled (default), Disabled.

Primary Master/Slave PIO

The IDE PIO (Programmed Input / Output) fields let you set a PIO mode (0-4) for each of the IDE devices that the onboard IDE interface supports. Modes 0 to 4 will increase performance progressively. In Auto mode, the system automatically determines the best mode for each device.

The Choices: Auto (default), Mode0, Mode1, Mode2, Mode3, Mode4.

TForce 570 U

Primary/Secondary Master/Slave UDMA

Ultra DMA function can be implemented if it is supported by the IDE hard drives in your system. As well, your operating environment requires a DMA driver (Windows 95 or OSR2 may need a third party IDE bus master driver). If your hard drive and your system software both support Ultra DMA, select Auto to enable BIOS support.

The Choices: Auto (default), Disabled.

IDE DMA Transfer Access

This item allows you to enable or disable the IDE DMA transfer access.

The Choices: Enabled (default), Disabled.

Serial-ATA Controller

The Choices: ALL Enabled (default), SATA-1, SATA-1+2, Disabled.

IDE Prefetch Mode

The “onboard” IDE drive interfaces supports IDE prefetch function for faster drive access. If the interface on your drive does not support prefetching, or if you install a primary and/or secondary add-in IDE interface, set this option to “Disabled”.

The Choices: Enabled (default), Disabled.

Onboard Device

Highlight the “Press Enter” label next to the “Onboard Device” label and press the enter key will take you a submenu with the following options:

Phoenix - Award Workstation BIOS CMOS Setup Utility (N550B-A2T)	
Onboard Device	
	Item Help
OnChip USB	[U1.1+U2.0]
USB Memory Type	[SHADOW]
USB Keyboard Support	[Disabled]
USB Mouse Support	[Disabled]
HD Audio	[Auto]
MAC Lan	[Auto]
MAC Media Interface	[Pin Strap]
Onboard Lan Boot ROM	[Disabled]

F5: Previous Values F7: Optimized Defaults

TForce 570 U

OnChip USB

This option should be enabled if your system has a USB installed on the system board. You may need to disable this feature if you add a higher performance controller.

The Choices: V1.1+V2.0 (default), Disabled, V1.1

USB Memory Type

The Choices: SHADOW (default), Base Memory(640K).

USB Keyboard Support

This item allows you to enable or disable the USB Keyboard Legacy Support.

Enabled Enable USB Keyboard Support.

Disabled (default) Disable USB Keyboard Support.

USB Mouse Support

This item allows you to enable or disable the USB Mouse Legacy Support.

Enabled Enable USB Mouse Support.

Disabled (default) Disable USB Mouse Support.

HD Audio

The Choices: Auto (default), Disabled.

MAC LAN

This option allows you to control the onboard MAC LAN.

The Choices: Auto (default), Disabled.

MAC Media Interface

This option allows you to control the onboard MAC Media Interface.

The Choices: Pin Strap (default), MII, RGMII.

Onboard LAN Boot ROM

This item allows you to enable or disable the Onboard LAN Boot ROM.

The Choices: Disabled (default), Enabled.

TForce 570 U

Onboard I/O Address

Press Enter to configure the Onboard I/O Address.

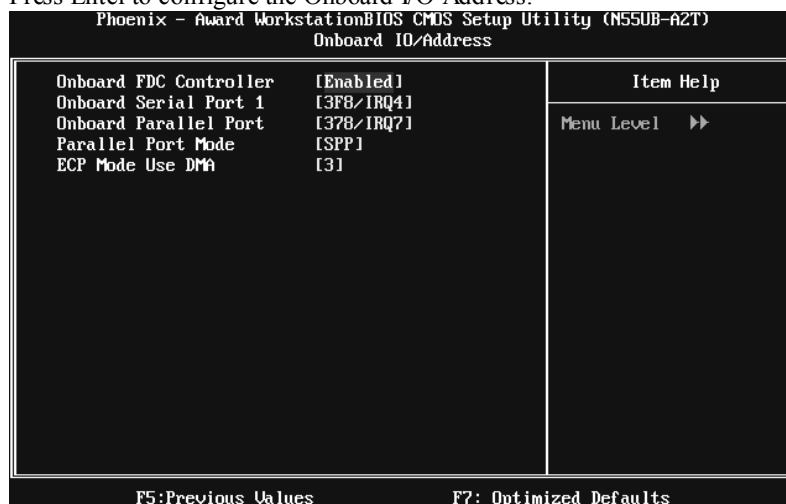

Onboard FDC Controller

Select enabled if your system has a floppy disk controller (FDC) installed on the system board and you wish to use it. If you installed another FDC or the system uses no floppy drive, select disabled in this field.

The Choices: Enabled (default), Disabled.

Onboard Serial Port 1

Select an address and corresponding interrupt for the first and second serial ports.

The Choices: 3F8/IRQ4 (default), Disabled, 2F8/IRQ3, 3E8/IRQ4, 2E8/IRQ3, Auto.

Onboard Parallel Port

This item allows you to determine access onboard parallel port controller with which I/O Address.

The Choices: 378/IRQ7 (default), 278/IRQ5, 3BC/IRQ7, Disabled.

TForce 570 U

Parallel Port Mode

This item allows you to determine how the parallel port should function. The default value is SPP.

The Choices:

SPP (default)	Using Parallel port as Standard Printer Port.
EPP	Using Parallel Port as Enhanced Parallel Port.
ECP	Using Parallel port as Extended Capabilities Port.
ECP+EPP	Using Parallel port as ECP & EPP mode.

ECP Mode Use DMA

Select a DMA Channel for the port.

The Choices: 3 (default), 1.

IDE HDD Block Mode

Block mode is also called block transfer, multiple commands, or multiple sectors read / write. If your IDE hard drive supports block mode (most new drives do), select Enabled for automatic detection of the optimal number of block mode (most new drives do), select Enabled for automatic detection of the optimal number of block read / write per sector where the drive can support.

The Choices: Enabled (default), Disabled.

TForce 570 U

6 Power Management Setup

The Power Management Setup Menu allows you to configure your system to utilize energy conservation and power up/power down features.

■ **Figure 6. Power Management Setup**

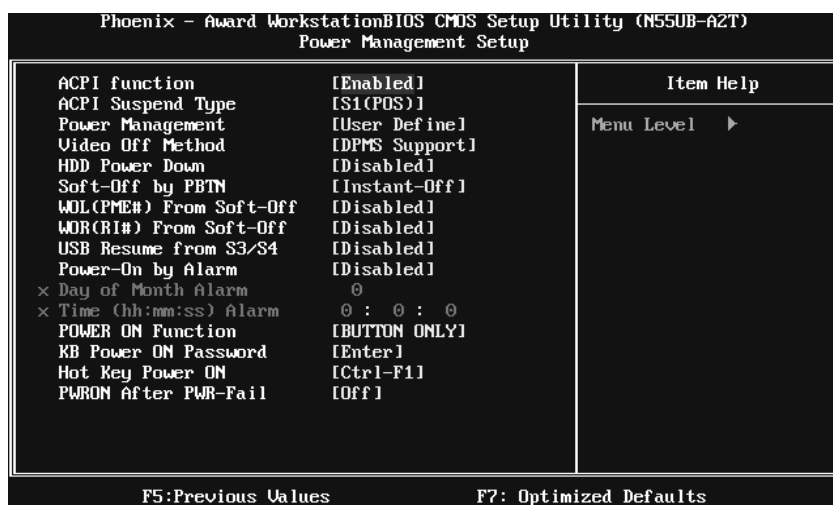

ACPI Function

This item displays the status of the Advanced Configuration and Power Management (ACPI).

The Choices: Enabled (default), Disabled.

ACPI Suspend Type

The item allows you to select the suspend type under the ACPI operating system.

The Choices: **S1 (POS)** (default) Power on Suspend
 S3 (STR) Suspend to RAM
 S1 & S3 POS+STR

TForce 570 U

Power Management

This category allows you to select the power saving method and is directly related to the following modes:

1. HDD Power Down.
2. Suspend Mode.

There are three options of Power Management, three of which have fixed mode settings

Min. Power Saving

Minimum power management.

Suspend Mode = 1 hr.

HDD Power Down = 15 min

Max. Power Saving

Maximum power management only available for s1 CPU's.

Suspend Mode = 1 min.

HDD Power Down = 1 min.

User Define (default)

Allow you to set each option individually.

When you choose user define, you can adjust each of the item from 1 min. to 1 hr. except for HDD Power Down which ranges from 1 min. to 15 min.

Video Off Method

This option determines the manner when the monitor goes blank.

V/H SYNC+Blank

This selection will cause the system to turn off the vertical and horizontal synchronization ports and write blanks to the video buffer.

Blank Screen

This option only writes blanks to the video buffer.

DPMS Support (default)

Initial display power management signaling.

HDD Power Down

When enabled, the hard-disk drives will power down after a set time of system inactivity. All other devices remain active.

The Choices: Disabled (default), 1 Min, 2 Min, 3 Min, 4 Min, 5 Min, 6 Min, 7 Min, 8 Min, 9 Min, 10 Min, 11 Min, 12 Min, 13 Min, 14 Min, 15Min.

TForce 570 U

Soft-Off by PWR-BTN

This item determines the behavior of system power button. Instant off turn off the power immediately, and Delay 4 Sec. will require you to press and hold the power button for 4 seconds to cut off the system power.

The Choices: Delay 4 Sec, **Instant-Off** (default).

WOL(PME#)/ From Soft-Off

This item allows you to enable or disable Wake On LAN from Soft-Off function.

The Choices: **Disabled** (default), Enabled.

WOR(RI#) From Soft-Off

This item allows you to enable or disable Wake On Ring from Soft-Off function.

The Choices: **Disabled** (default), Enabled.

USB Resume From S3/S4

This item allows you to enable or disabled the USB resume from S3/S4 function.

The Choices: **Disabled** (default), Enabled.

Power-On by Alarm

This function is for setting date and time for your computer to boot up. When enabled, you can choose the date and time to boot up the system.

The Choices: **Disabled** (default), Enabled.

Date (of Month) Alarm

You can choose which month the system will boot up.

Time (hh:mm:ss) Alarm

You can choose the system boot up time, input hour, minute and second to specify.

Note: If you have change the setting, you must let the system boot up until it goes to the operating system, before this function will work.

TForce 570 U

POWER ON Function

This item allows you to choose the power on method.

The Choices: **Button Only**(default), Password, Hot Key, Mouse/Click, Mouse Double/Click, Any Key, Keyboard 98.

KB Power ON Password

Input password and press Enter to set the Keyboard power on password.

Hot Key Power ON

Choose the Hot Key combination to boot up the system.

The Choices: **Ctrl-F1**(default), Ctrl-F2, Ctrl-F3, Ctrl-F4, Ctrl-F5, Ctrl-F6, Ctrl-F7, Ctrl-F8, Ctrl-F9, Ctrl-F10, Ctrl-F11, and Ctrl-F12.

POWER After PWR-Fail

This setting specifies how your system should behave after a power fail or interrupts occurs. By choosing off will leave the computer in the power off state. Choosing On will reboot the computer. Former-Sts will restore the system to the status before power failure or interrupt occurs.

The Choices: **Off** (default), On, Former-Sts.

TForce 570 U

7 PnP/PCI Configurations

This section describes configuring the PCI bus system. PCI, or Personal Computer Interconnect, is a system which allows I/O devices to operate at speeds nearing the speed of the CPU itself uses when communicating with its own special components. This section covers some very technical items and it is strongly recommended that only experienced users should make any changes to the default settings.

■ **Figure 7: PnP/PCI Configurations**



Init Display First

This item allows you to decide to active whether PCI Slot or on-chip VGA first.
The Choices: PCIe, PCI Slot (default), Onboard.

Reset Configuration Data

The system BIOS supports the PnP feature which requires the system to record which resources are assigned and protects resources from conflict. Every peripheral device has a node, which is called ESCD. This node records which resources are assigned to it. The system needs to record and update ESCD to the memory locations. These locations are reserved in the system BIOS. If the Disabled (default) option is chosen, the system's ESCD will update only when the new configuration varies from the last one. If the Enabled option is chosen,

TForce 570 U

the system is forced to update ESCDs and then is automatically set to the “Disabled” mode.

The above settings will be shown on the screen only if “Manual” is chosen for the resources controlled by function.

Legacy is the term, which signifies that a resource is assigned to the ISA Bus and provides non-PnP ISA add-on cards. PCI / ISA PnP signify that a resource is assigned to the PCI Bus or provides for ISA PnP add-on cards and peripherals.

The Choices: Disabled (default), Enabled.

Resources Controlled By

By Choosing “Auto(ESCD)” (default), the system BIOS will detect the system resources and automatically assign the relative IRQ and DMA channel for each peripheral. By Choosing “Manual”, the user will need to assign IRQ & DMA for add-on cards. Be sure that there are no IRQ/DMA and I/O port conflicts.

The Choices: Auto (ESCD) (default), Manual.

IRQ Resources

This submenu will allow you to assign each system interrupt a type, depending on the type of device using the interrupt. When you press the “Press Enter” tag, you will be directed to a submenu that will allow you to configure the system interrupts. This is only configurable when “Resources Controlled By” is set to “Manual”.

IRQ-5	assigned to PCI Device
IRQ-7	assigned to PCI Device
IRQ-9	assigned to PCI Device
IRQ-10	assigned to PCI Device
IRQ-11	assigned to PCI Device
IRQ-14	assigned to PCI Device
IRQ-15	assigned to PCI Device

PCI / VGA Palette Snoop

Some old graphic controllers need to “snoop” on the VGA palette and then map it to their display as a way to provide boot information and VGA compatibility. This item allows such snooping to take place.

The Choices: Disabled (default), Enabled

TForce 570 U

Maximum Payload Size

Set the maximum payload size for Transaction packets (TLP).

The Choice: 4096 (default.), 128, 256, 512, 1024, 2048.

TForce 570 U

8 PC Health Status

■ Figure 8: PC Health Status



Shutdown Temperature

This item allows you to set up the CPU shutdown Temperature. This item is only effective under Windows 98 ACPI mode.

The Choices: Disabled , 60°C / 140°F , 65°C / 149°F , **70°C / 158°F** (default).

Show HW Monitor in POST

If your computer contains a monitoring system, it will show PC health status during POST stage. The item offers several different delay times.

The Choices: Enabled (default), Disabled.

CPU FAN Control by

Choose “smart” to reduce the noise caused by CPU FAN.

The Choices: Always On (default), Smart.

SYS FAN Control by

Choose “smart” to reduce the noise caused by the System FAN.

TForce 570 U

The Choices: Smart, Always On (default).

CPU Fan Off<°C>

If the CPU Temperature is lower than the set value, FAN will turn off.

The Choices: Min=0, Max=127, Key in a DEC number.

CPU Fan Start<°C>

CPU fan starts to work under smart fan function when arrive this set value.

The Choices: Min=0, Max=127, Key in a DEC number.

CPU Fan Full speed <°C>

When CPU temperature is reach the set value, the CPU fan will work under Full Speed.

The Choices: Min=0, Max=127, Key in a DEC number.

Start PWM Value

When CPU temperature arrives to the set value, the CPU fan will work under Smart Fan Function mode. The range is from 0~127, with an interval of 1.

The Choices: Min=0, Max=127, Key in a DEC number.

Slope PWM

Increasing the value of slope PWM will raise the speed of CPU fan.

The Choices: 0 PWM Value/°C, 1 PWM Value/°C, **2 PWM Value/°C** (default), 4 PWM Value/°C, 8 PWM Value/°C, 16 PWM Value/°C, 32 PWM Value/°C, 64PWM Value/°C.

CPU Vcore, Chipset Volt, +3.3V, +5.0V, +12.0V, DDR Voltage, HT Voltage, 5V<SB>, Voltage Battery

Detect the system's voltage status automatically.

SYSTEM Temp

This field displays the current temperature of SYSTEM.

CPU Temp

This field displays the current temperature of CPU.

TForce 570 U

Current CPU FAN Speed

This field displays the current speed of CPU fan.

Current SYS FAN Speed

This field displays the current speed SYSTEM fan.

Current NB FAN Speed

This field displays the current speed NB fan.

TForce 570 U

9 OverClock Navigator Engine

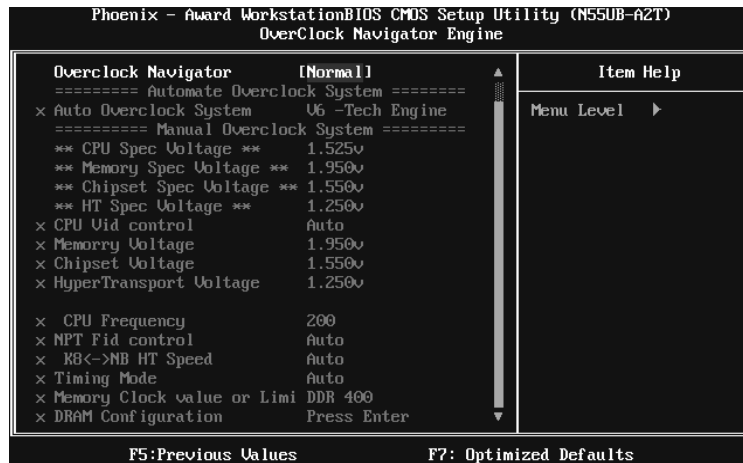

OverClock Navigator

OverClock Navigator is designed for beginners in overlock field. Based on many test and experiments from Biostar Engineer Team, OverClock Navigator provides 3 default overlock configurations that are able to raise the system performance

The Choices: Normal (default), Automate Overclock, Manual Overlock

TForce 570 U

Auto OverClock System

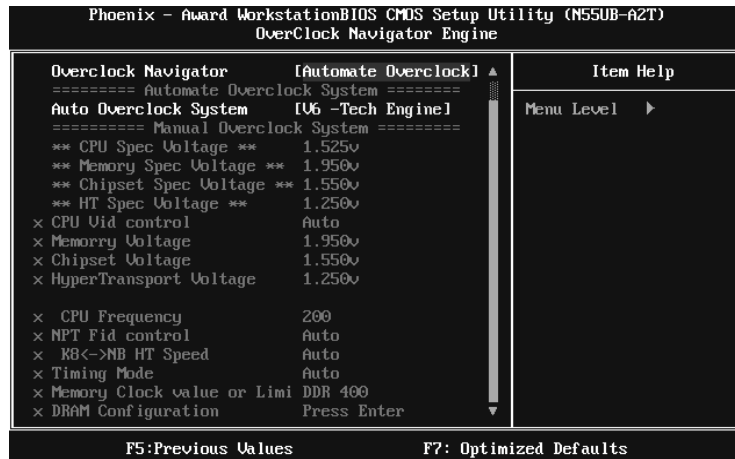

The Overclock Navigator provides 3 different engines helping you to overclock your system. These engines will boost your system performance to different level.

The Choices:

V6 Tech Engine

This setting will raise about 5%~10% of whole system performance.

V8 Tech Engine

This setting will raise about 15%~25% of whole system performance.

V12 Tech Engine

This setting will raise about 25%~30% of whole system performance.

Cautions:

1. Not every AMD CPU performs the above overclock setting ideally; the difference may vary with the installed CPU model.
2. From BET experiment, the Atholon64 FX CPU is not suitable for this A.O.S. feature.

TForce 570 U

Manual Overclock System (M.O.S.)



MOS is designed for experienced overclock users.

It allows users to customize personal overclock setting.

Note:

Based on our test results; the overclock function achieved the best performance on AMD 3000+ CPU

CPU Vid control

The Choices: Auto (default), 0.800v~2.310v.

Memory Voltage

The Choices: 1.950V (default), 2.000V, 2.050V, 2.100V.

Chipset Voltage

The Choices: 1.550V (default), 1.600V, 1.650V, 1.700V.

HyperTransport Voltage

The Choices: 1.250V (default), 1.300V, 1.350V, 1.400V.

CPU Frequency

This item allows you to select the CPU Frequency.

The Choices: 200 (default), 201~450.

NPT Vid control

The Choices: AUTO (default), x4 800Mhz~x25 5000Mhz.

TForce 570 U

K8->NB HT Speed

The Choices: AUTO (default), 1x, 2x, 3x, 4x, 5x.

Timing Mode

This item allows you to choose to manually or automatically regulate the DDR Timing.

The Choices: Auto (default), MaxMemClk.

Memory Clock Value or Limi

The Choices: DDR 400 (default), DDR 533, DDR 667, DDR 800.

DRAM Configuration

Phoenix - Award Workstation BIOS CMOS Setup Utility (N55UB-A2T)
DRAM Configuration

▶ Memory Timings	[Press Enter]		
▶ Drive Strength setting	[Press Enter]		
▶ Dram on-die Termination	[Auto]		
Read/Write Queue bypass	[Auto]		
Bypass Maximum	[Auto]		
32 Byte Granularity	[Auto]		
DQS Training Control	[Skip DQS]		
CKE base power down mode	[Disabled]		
CKE based powerdown	[Per Channel]		
Memclock tri-stating	[Disabled]		
Memory Hole Remapping	[Enabled]		
Auto Optimize Bottom IO	[Enabled]		
× Bottom of [31:24] IO space	C0		
DDR11 Timing Item	[Disabled]		
× tWtr Command Delay	3 bus clocks		
× Trfc0 for DIMM0	75ns		
× Trfc1 for DIMM1	75ns		
× Trfc2 for DIMM2	75ns		
× Trfc3 for DIMM3	75ns		

F5: Previous Values F7: Optimized Defaults

Memory Timings

Phoenix - Award Workstation BIOS CMOS Setup Utility (N55UB-A2T)
Memory Timings

Parameters	Setting	Current Value	Item Help
tCL (CAS Latency)	[Auto]		Menu Level >>>> CAS# latency (CAS# to read data valid)
tRCD	[Auto]		
tRP	[Auto]		
tRAS	[Auto]		
Command Per Clock (CMD)	[Auto]		
tRRD	[Auto]		
AsyncLat	[Auto]		
tRC	[Auto]		
tWR	[Auto]		
tRWT	[Auto]		
tWTR	[Auto]		
tREF	[Auto]		
Read DQS Skew	[Auto]		
Read delay from Rx FIFO	[Auto]		

F5: Previous Values F7: Optimized Defaults

TForce 570 U

tCL(CAS Latency)

The Choices: **Auto** (default), 3 clock ~ 6 clock.

tRCD

The Choices: **Auto** (default), 3 clock ~ 6 clock.

tRP

The Choices: **Auto** (default), 3 clock ~ 6 clock.

tRAS

The Choices: **Auto** (default), 5 clock ~ 18 clock.

Command Per Clock (CMD)

The Choices: **Auto** (default), 1 clock ~ 2 clock.

tRRD

The Choices: **Auto** (default), 2 clock ~ 5 clock.

AsyncLat

The Choices: **Auto** (default), 1ns ~ 15ns.

tRC

The Choices: **Auto** (default), 11 clock ~ 26 clock.

tWR

The Choices: **Auto** (default), 3 clock ~ 6 clock.

tRWT

The Choices: **Auto** (default), 2 clock ~ 9 clock.

tWTR

The Choices: **Auto** (default), 1 clock ~ 3 clock.

tREF

The Choices: **Auto** (default), 7.8 us, 3.9 us.

Read DQS Skew

The Choices: **Auto** (default), -10/96 clock ~ +10/96 clock.

Read delay from Rx FIFO

The Choices: **Auto** (default), 0.5 clock ~ 4.0 clock.

TForce 570 U

Drive Strength setting

Phoenix - Award Workstation BIOS CMOS Setup Utility (N550B-A21)			
Drive Strength setting			
Parameters	Setting	Current Value	Item Help
Dram driver weak mode	[Auto]		Menu Level >>>>
CKE drive strength	[Auto]		
CS drive strength	[Auto]		
MA drive strength	[Auto]		
MCLK drive strength	[Auto]		
MD drive strength	[Auto]		
DQS drive strength	[Auto]		

F5: Previous Values F7: Optimized Defaults

Dram driver weak mode

The Choices: Auto (default), Normal, Weak.

CKE drive strength

The Choices: Auto (default), 1.0x, 1.25x, 1.5x, 2.0x.

CS drive strength

The Choices: Auto (default), 1.0x, 1.25x, 1.5x, 2.0x.

MA drive strength

The Choices: Auto (default), 1.0x, 1.25x, 1.5x, 2.0x.

MCLK drive strength

The Choices: Auto (default), 0.75x, 1.0x, 1.25x, 1.50x.

MD drive strength

The Choices: Auto (default), 0.75x, 1.0x, 1.25x, 1.50x.

DQS drive strength

The Choices: Auto (default), 0.75x, 1.0x, 1.25x, 1.50x.

Dram on-die Termination

The Choices: Auto (default), Disable, 75ohm, 150ohm, 50ohm.

Read/Write Queue bypass

The Choices: Auto (default), 2 times, 4 times, 8 times, 16 times.

TForce 570 U

Bypass Maximum

The Choices: **Auto** (default), No bypass, 1 time ~ 15 time.

32 Byte Granularity

The Choices: **Auto** (default), 64-byte, 32-byte.

DQS Training Control

The Choices: Perform DQS, **Skip DQS** (default).

CKE base power down mode

The Choices: Enabled, **Disabled**(default).

CKE based power down

The Choices: **Per Channel** (default), Per CS.

Memclock tri-stating

The Choices: **Disabled** (default), Enabled.

Memory Hole Remapping

The Choices: **Enabled** (default), Disabled.

Auto Optimize Bottom IO

The Choices: **Enabled** (default), Disabled.

Bottom of [31:24] IO space

The Choices: **C0** (default); Min=0000, Max=00FF, key in a HEX number.

DDRII Timing Item

The Choices: **Disabled** (default), Enabled.

TwTr Command Delay

The Choices: **3 bus clocks** (default), 1 bus clocks, 2 bus clocks.

TrTfc0 for DIMM0

The Choices: **75ns** (default), 105ns, 127.5ns, 195ns, 327.5ns.

TrTfc1 for DIMM1

The Choices: **75ns** (default) , 105ns, 127.5ns, 195ns, 327.5ns.

TrTfc2 for DIMM2

The Choices: **75ns** (default) , 105ns, 127.5ns, 195ns, 327.5ns.

TrTfc3 for DIMM3

The Choices: **75ns** (default) , 105ns, 127.5ns, 195ns, 327.5ns.

TForce 570 U

<Twr> Write Recovery Time

The Choices: 6 bus clocks (default), 3 bus clocks, 4 bus clocks, 5 bus clocks.

<Trtp> Precharge Time

The Choices: 3 clocks (default), 2 clocks.

<Trc> Row Cycle Time

The Choices: 26 bus clocks (default), 11-25 bus clocks.

<Trcd> RAS to CAS R/W Delay

The Choices: 6 clocks (default), 3 clocks, 4 clocks, 5 clocks.

<Trrd> RAS to RAS Delay

The Choices: 5 clocks (default), 2 clocks, 3 clocks, 4 clocks.

<Trp> Row Precharge Time

The Choices: 6 clocks (default), 3 clocks, 4 clocks, 5 clocks.

<Tras> Minimum RAS Active T

The Choices: 18 bus clocks (default), 5-17 bus clocks.

TForce 570 U

Integrated Memory Test

Integrated Memory Test allows users to test memory module compatibilities without additional device or software.

Step 1:

This item is disabled on default; change it to “Enable” to precede memory test.

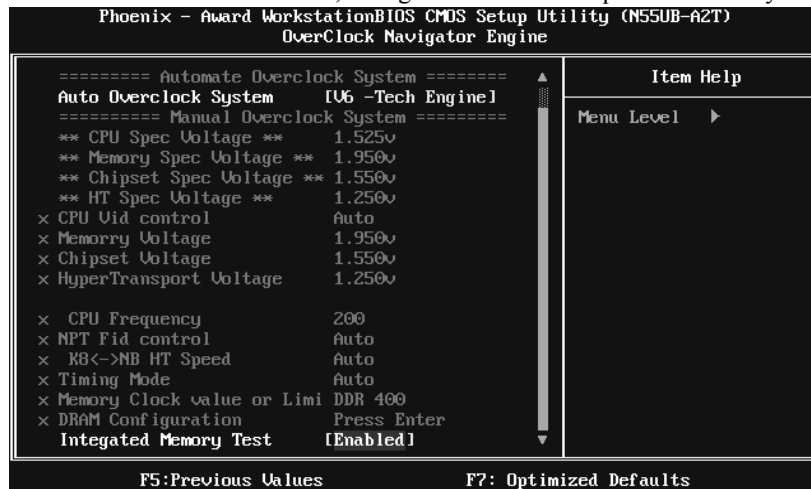

Step 2:

When the process is done, change the setting back from “Enabled” to “Disabled” to complete the test.

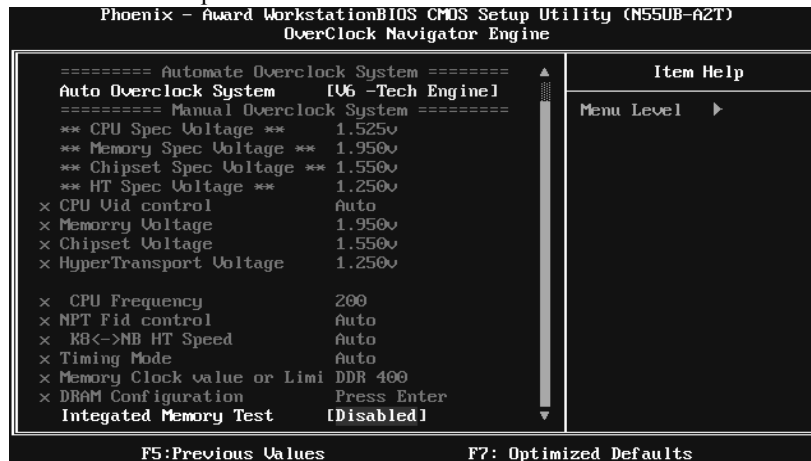

TForce 570 U

10 CMOS Reload Program (C.R.P.)

The CMOS Reload Program (CRP) allows you to save different CMOS settings into BIOS-ROM. You may reload any saved CMOS setting to change system configurations. Moreover, you may save your ideal overclock setting for easier overclocking. There are 50 sets record addresses in total, and you may name the saved CMOS data individually.

